



UM5003D

3 Sec Voice Synthesizer with Serial/Random Trigger

Features

- Operating Voltage Range: 2.4V - 5.5V
- Single power supply
- Typical 3 second voice duration
- Built-in on-chip ROM with capacity up to 20 separate words
- 4 voice sections. Each section contains a maximum of 7 words
- Directly drives piezo buzzer
- Audio current output by D/A converter
- Provides level/edge trigger mode control for all sections
- Repeat function can be up to 16 times for each selected section
- Re-triggerable for all trigger-in pins
- CDS trigger function (TRG4 only)
- Directly drives LED which flashes at 0, 3, and 6 Hz rate (Based on 6 KHz sampling rate) selected by mask option
- Stop pulse issued from stop pin after every section by mask option, depending on user's application
- Mask options for:
 - Voice data for words
 - Various word combinations for every section
 - Repeats up to 16 times
 - Mute intervals (maximum 5 sec.) for every section
 - Edge or level trigger mode for every section
 - The generation of stop pulse is optional
 - LED flash rate (3, 6 Hz) or BUSY (0 Hz)
 - STOP mode: Immediately stops or stops at the end of section
- Cascade function can extend the voice duration by N x 3 seconds with N pieces of UM5003D
- Parallel function can increase the number of sections by 4 x N with N pieces of UM5003D
- Cascade function can trigger melody chip at the end of voice
- Clock frequency is adjustable by external resistor, sampling rates range from 3 KHz to 10 KHz
- Built-in key debouncing circuit
- Automatic power down
- Available in 14-pin DIP and in CHIP FORM

General Description

The UM5003D is a single-chip voice synthesizing CMOS VLSI that can synthesize a voice up to 3 seconds. It contains most of the necessary circuitry, therefore it can be applied to various voice systems

with minimal external parts. Voice data and control modes can be programmed by changing a single mask during the device fabrication.

Pin Configuration

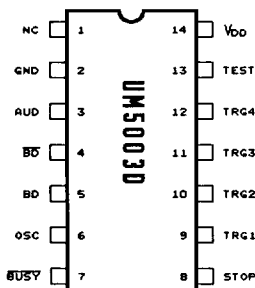

Pad Configuration

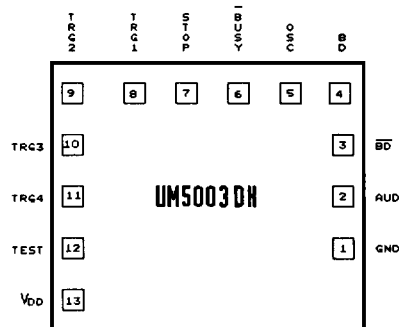

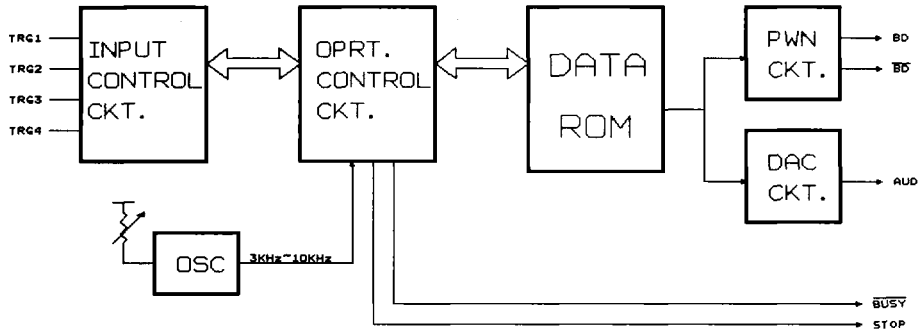
Block Diagram

Absolute Maximum Ratings*

DC Supply Voltage	-0.3V to +7V
Input Voltage	GND - 0.3V to VDD + 0.3V
Operating Ambient Temperature.	-10°C to + 60°C
Storage Temperature	-50°C to + 125°C

***Comments**

Stresses above those listed under *Absolute Maximum Ratings* may cause permanent damage to the device. These are stress ratings only. Functional operation of this device at these or any other conditions above those indicated in the operational sections of this specification is not implied and exposure to absolute maximum rating conditions for extended periods may affect device reliability.

DC Electrical Characteristics (Ta = 25 °C)

Parameter	Symbol	Min.	Typ.	Max.	Unit	Conditions
Operating Voltage	VDD	2.4	4.5	5.5	V	
Operating Current	Iop	-	-	3.0	mA	VDD = 4.5V
Standby Current	I _{sb}	-	0.5	2	μA	All I/O Pull Low VDD = 3.0V
Input Voltage (TRG1— TRG4)	V _{ih}	2.4	3.0	-	V	VDD = 3.0V
	V _{il}	-	0.0	-	V	
Input Current (TRG1— TRG3)	I _{ih}	-	-	65	μA	VDD = 4.5V, V _{in} = 4.5V
	I _{il}	-	0.0	-	μA	VDD = 4.5V, V _{in} = 0.0V
Input Current (TRG4)	I _{ih}	-	-	5	μA	VDD = 4.5V, V _{in} = 4.5V
	I _{il}	-	0.0	-	μA	VDD = 4.5V, V _{in} = 0.0V
AUD Output Current (half scale value)	I _{oc}	-1.7	-2.0	-2.4	mA	VDD = 4.5V, V _{out} = 0.7V
Output Current (BD & BD-bar)	I _{oh}	-	-5	-4.5	mA	VDD = 4.5V, V _{oh} = 4.0V
	I _{ol}	-	100	-	μA	VDD = 3.0V, V _{out} = 2.5V

DC Electrical Characteristics (continued)

Parameter	Symbol	Min.	Typ.	Max.	Unit	Conditions
Output Current (STOP)	Ioh	-	-	-1.5	mA	VDD = 4.5V, Vout = 4.0V
	Iol	1.8	-	-	mA	VDD = 4.5V, Vout = 0.5V
Output Current (BUSY)	Ioh	-100	-	-20	μA	VDD = 3.0V, Vout = 1.2V
	Iol	4.0	-	9.0	mA	VDD = 3.0V, Vout = 0.5V
Frequency Stability	$\Delta F/F$	-	-	5	%	$\frac{F_{osc}(4.5V) - F_{osc}(4.0V)}{F_{osc}(4.5V)}$
Frequency Variation	$\Delta F/F$	-	-	15	%	VDD = 4.5V

AC Characteristics

Parameter	Symbol	Min.	Typ.	Max.	Unit	Conditions
STOP Pulse Width	Twsp	18	18.6	19	ms	Typ. Fs = 6.0 KHz
Debounce Time (TRG1 - TRG4) (KEY ON)	Tdin	7	8	9	ms	Typ. Fs = 6.0 KHz
Debounce Time (TRG1 - TRG4) (KEY RELEASE)	Tdr	27	30	33	ms	Typ. Fs = 6.0 KHz

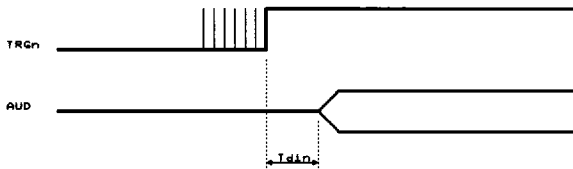
Timing Waveforms
(1) Input Pin Key-in Debounce

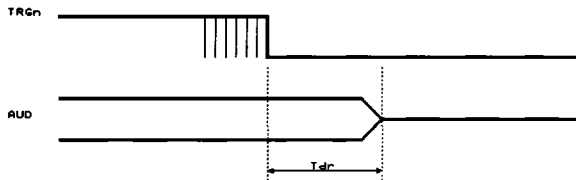
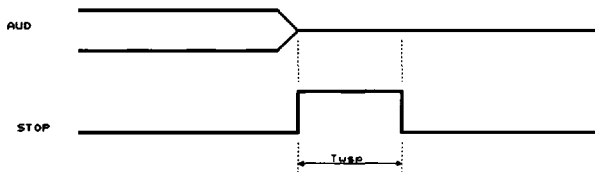
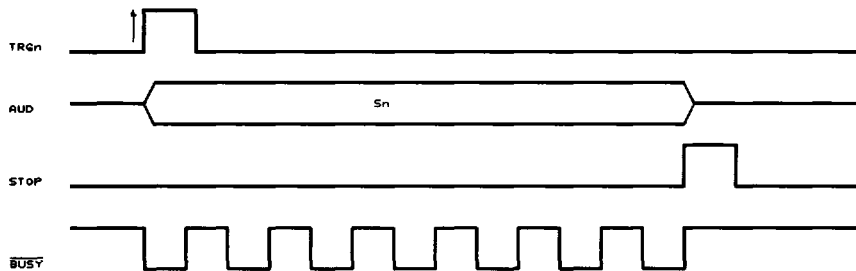
Timing Waveforms (continued)
(2) Input Pin Key-release Debounce

(3) Stop Signal Pulse Width

(4) Edge Trigger Mode
(a) Trigger Signal Returning to Zero

* $\overline{\text{BUSY}}$ output frequency selectable by mask option.

* n: 1 - 4

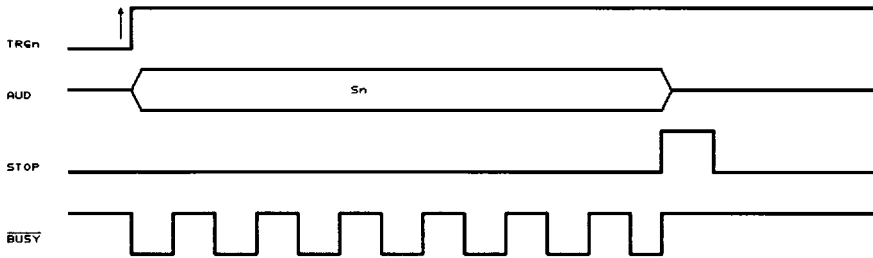
Timing Waveforms (continued)

(b). Trigger Signal Non-returning to Zero

Retriggerable

(c). Retriggering the Same Trigger Pin

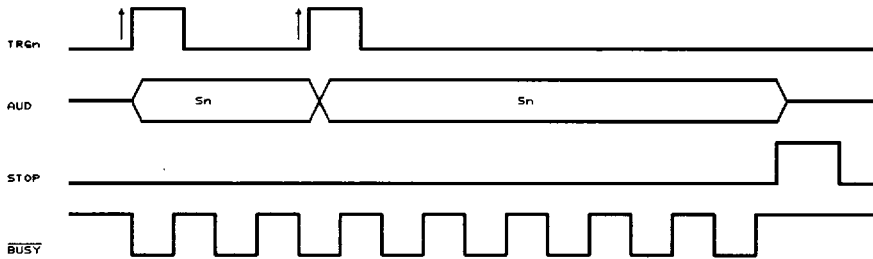

(d). Retriggering Different Trigger Pin

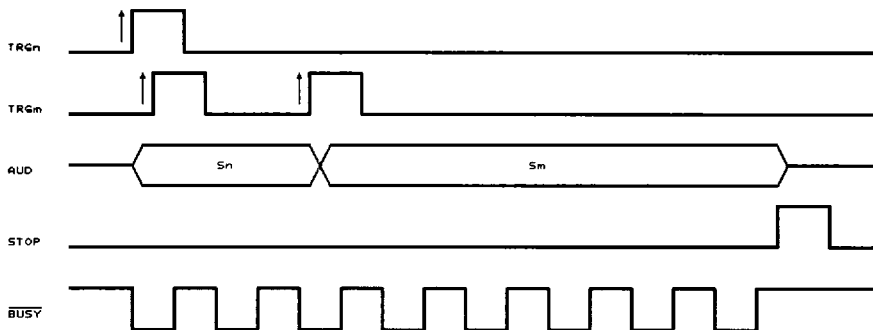

* In RETRIGGERABLE mode, last section will override the previous section.
 * BUSY output frequency selectable by mask option.
 * n, m: 1 - 4

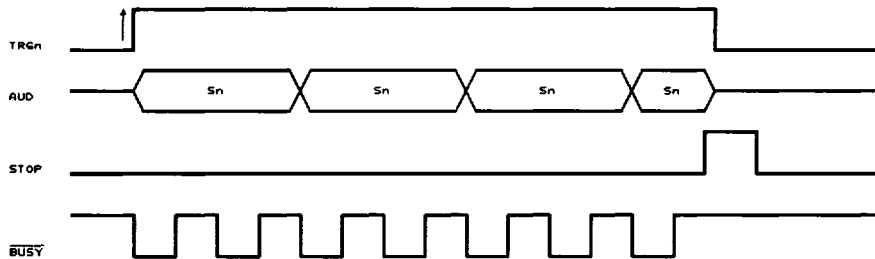
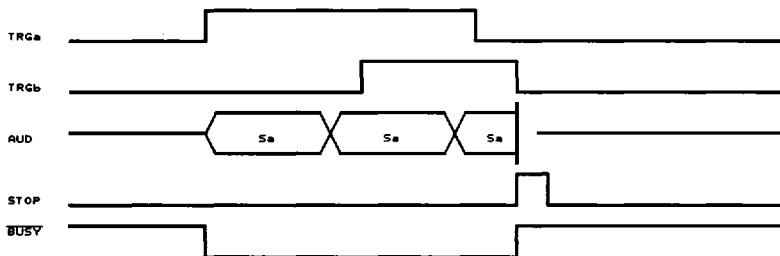
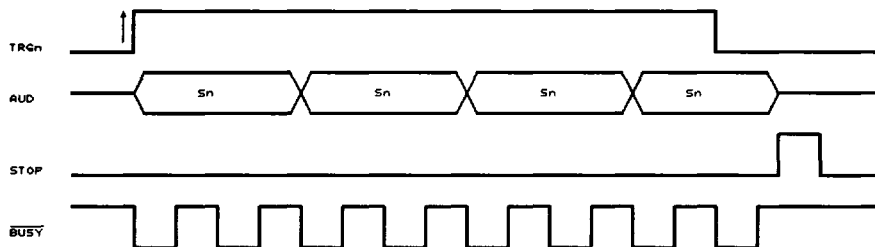
Timing Waveforms (continued)
(5) Level Trigger Mode
■ STOP mode: Immediate Stops
(a)

(b)

■ STOP mode: Stops after Last Section Ends
(c)

* $\overline{\text{BUSY}}$ output frequency selectable by mask option.

* n, m : 1 - 4

* n > m

* a, b : 1 - 4

Timing Waveforms (continued)
■ STOP mode: Stops after Last Section Ends (continued)

(d)

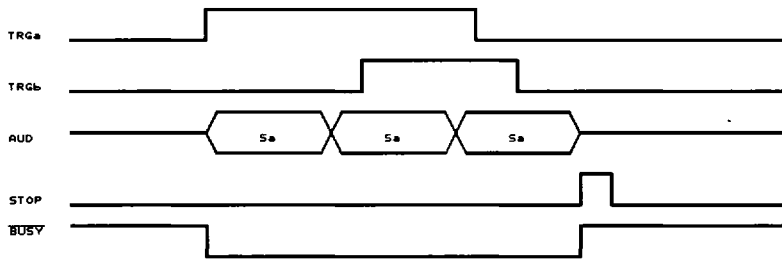
■ STOP mode: Includes both Immediate Stops and Stops after Last Section Ends

(e)

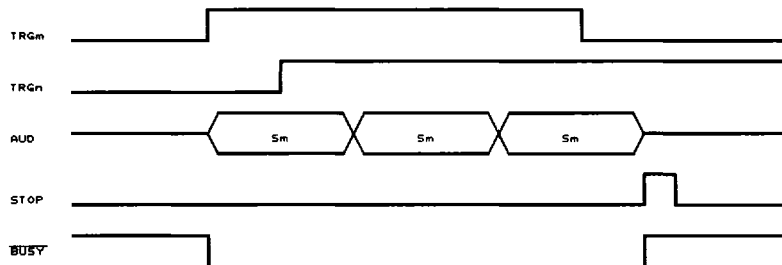

(f)

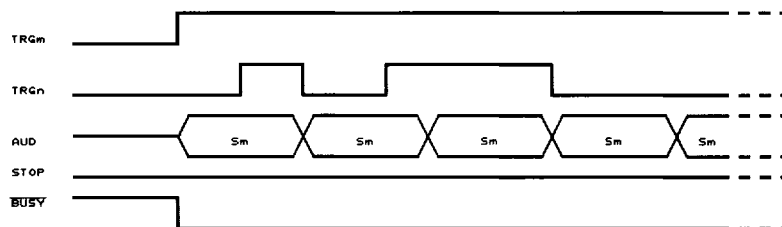
 * $\overline{\text{BUSY}}$ output frequency selectable by mask option.

* n, m : 1 - 4

 * $n > m$

* a, b: 1 - 4

Timing Waveforms (continued)

■ **STOP mode: Includes both Immediate Stops and Stops after Last Section Ends (continued)**

(g)

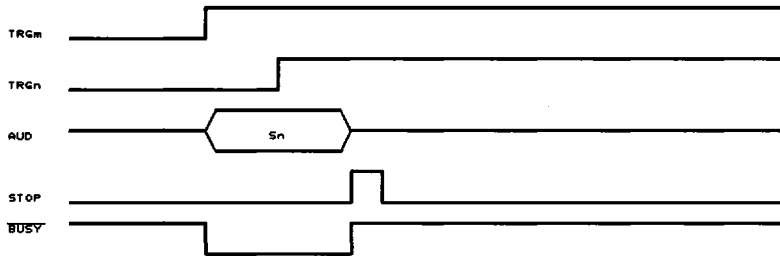

(h)

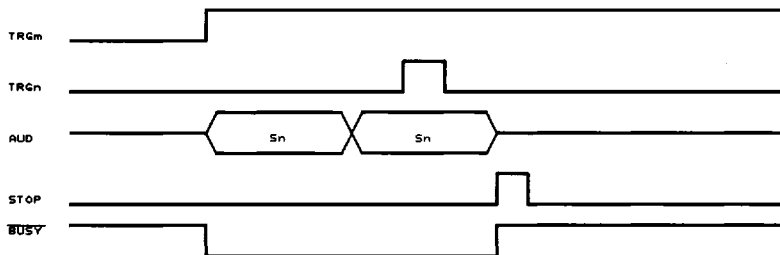

* BUSY output frequency selectable by mask option.

* n, m : 1 - 4

* n > m

* a, b : 1 - 4

Pin and Pad Descriptions

Pin No.	Pad No.	Designation	Description
1		NC	No connection
2	1	GND	Ground
3	2	AUD	Audio current output
4	3	$\overline{\text{BD}}$	Piezo buzzer driver tri-state output. When no sound outputs, these two pins will remain floating.
5	4	BD	
6	5	OSC	RC oscillator input. Changing the value of external pull high resistor achieves the following: Oscillator frequencies from 384 KHz to 1280 KHz Sampling rates from 3 KHz to 10 KHz
7	6	$\overline{\text{BUSY}}$	Voice BUSY denotation and direct drive LED
8	7	STOP	Stop pulse output (Active high)
9 - 12	8 - 11	TRG1 - TRG4	Trigger-in for 4 sections (Floating low) (With built-in pull low resistor)
13	12	TEST	For Testing (Normally open)
14	13	VDD	Positive power supply

Functional Description

Word Combinations

- Maximum of 20 words

Built-in ROM code can be separated up to 20 partitions of words. The duration of all words can range from 0 sec. to a maximum of 3 sec. (typical 6K sampling rate) of voice capacity.

- 4 sections

Each section can have a different combination of words (the display sequence of words). The maximum number of words that one section can contain is 7. The total number of words that can be used by 4 sections is 20.

- Mute interval

If needed user can add a mute interval at the end of every word. The range of duration for the mute interval is from 0 sec to 5 sec (typical 6K sampling rate).

CDS Trigger Function

To turn on the trigger by the CDS, its resistor must be less than 200K Ω . To turn off the trigger, the CDS resistor must be over 1M Ω .

$$\text{Transition point of inverter} = \frac{V_{DD}}{2}$$

CDS Trigger Circuit

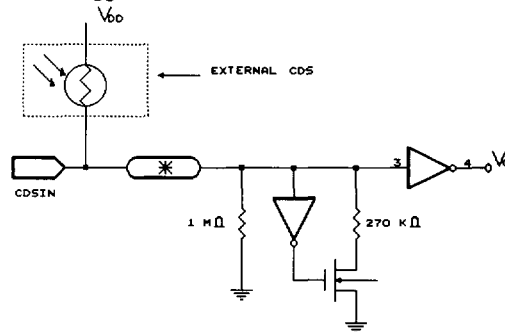

Application Circuits (for reference only)

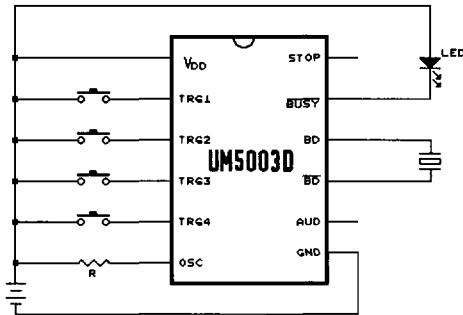
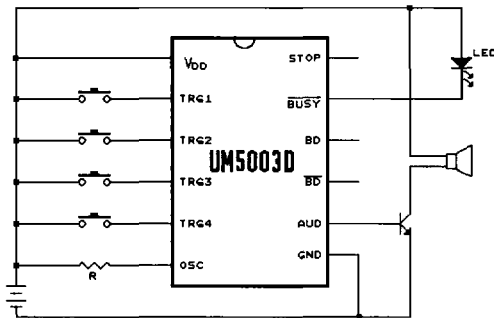
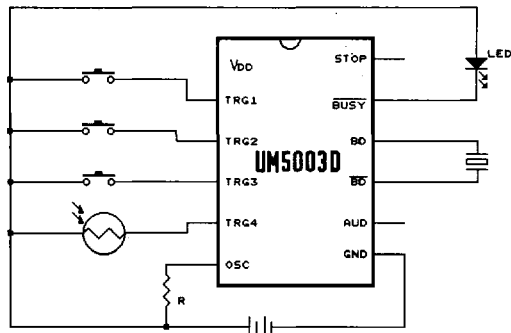
(1) Typical Applications
(a) Buzzer Output

(b) Speaker Output

(c) CDS Function

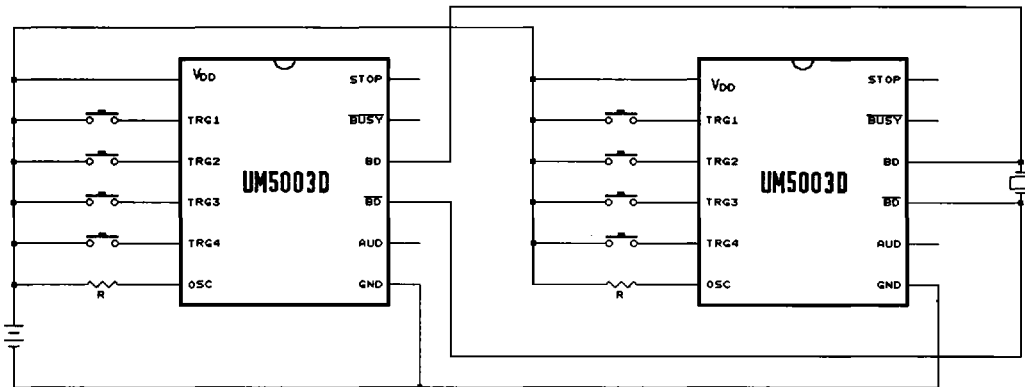
Application Circuits (continued)
(2) Parallel Applications

(a) Buzzer Output

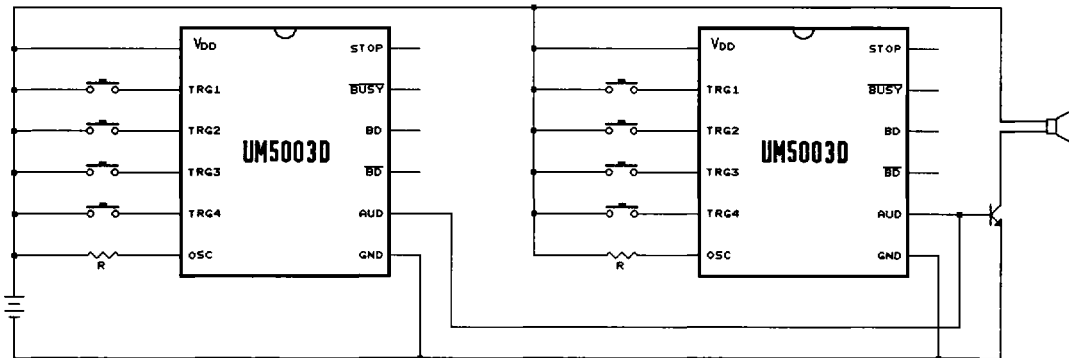

(b) Speaker Output

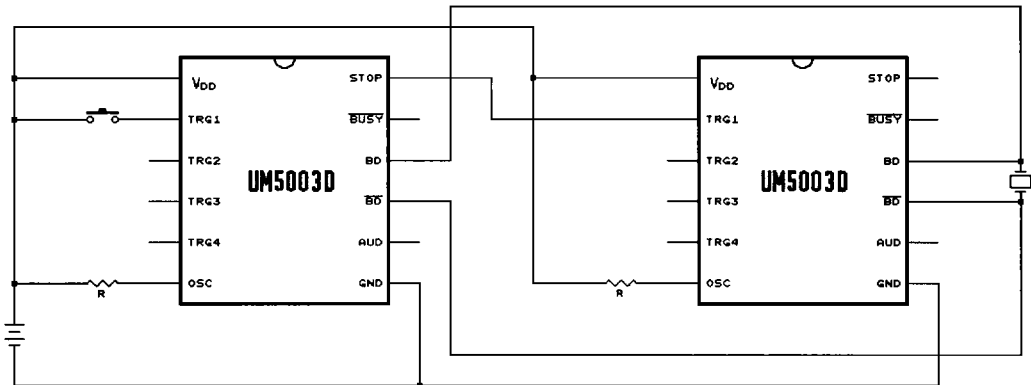
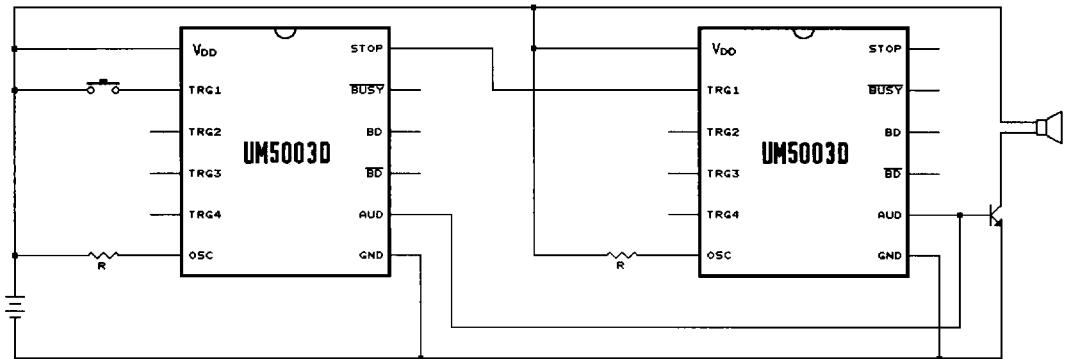

* Buzzer (BD, \overline{BD}) and speaker (AUD) output application cannot be used simultaneously.

Application Circuits (continued)
(3) Cascade Applications
(a) Buzzer Output

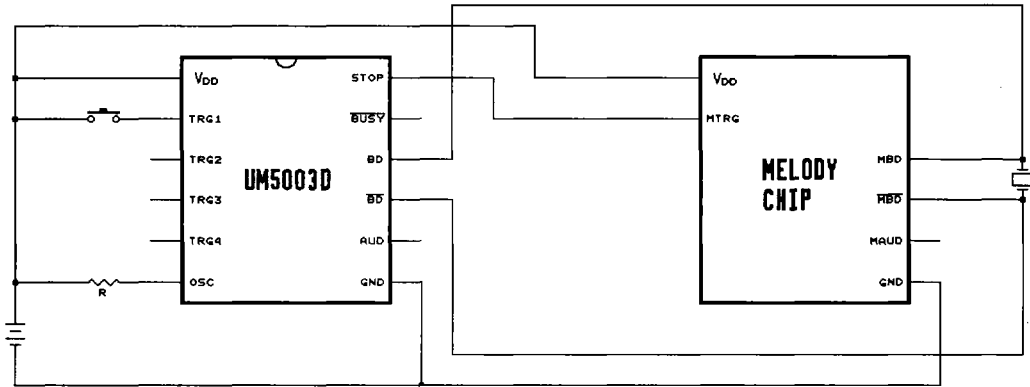
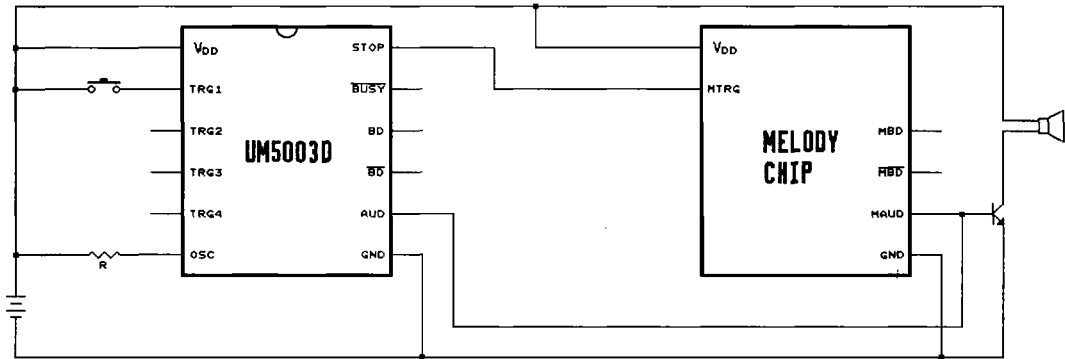
(b) Speaker Output

Application Circuits (continued)
(4) Voice with Melody Applications
(a) Buzzer Output*

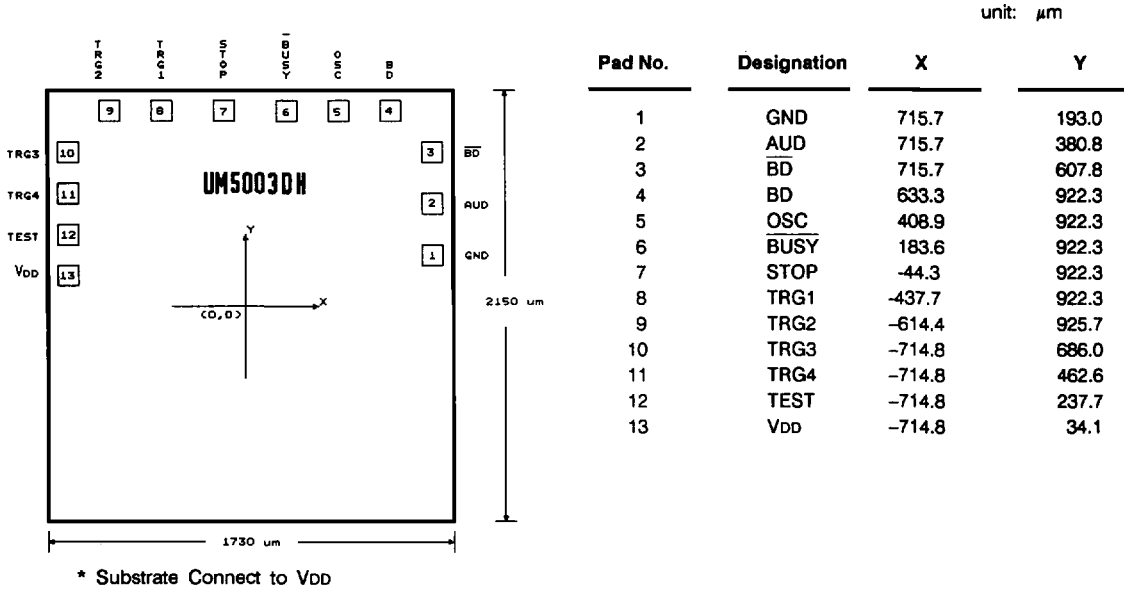
(b) Speaker Output

* In the melody application with the buzzer output, melody must have tri-state output.

Bonding Diagram

Ordering Information

Part No.	Package
UM5003DH - XX	CHIP FORM
UM5003D - XX	14L DIP

XX: Code numbering assigned per customer specifications
 X: 0 - 9, A - Z