

## LM1949 Injector Drive Controller

### General Description

The LM1949 linear integrated circuit serves as an excellent control of fuel injector drive circuitry in modern automotive systems. The IC is designed to control an external power NPN Darlington transistor that drives the high current injector solenoid. The current required to open a solenoid is several times greater than the current necessary to merely hold it open; therefore, the LM1949, by directly sensing the actual solenoid current, initially saturates the driver until the "peak" injector current is four times that of the idle or "holding" current (Figure 3–Figure 7). This guarantees opening of the injector. The current is then automatically reduced to the sufficient holding level for the duration of the input pulse. In this way, the total power consumed by the system is dramatically reduced. Also, a higher degree of correlation of fuel to the input voltage pulse (or duty cycle) is achieved, since opening and closing delays of the solenoid will be reduced.

Normally powered from a 5V  $\pm$  10% supply, the IC is typically operable over the entire temperature range ( $-55^{\circ}\text{C}$  to  $+125^{\circ}\text{C}$  ambient) with supplies as low as 3 volts. This is particularly useful under "cold crank" conditions when the battery voltage may drop low enough to deregulate the 5-volt power supply.

The LM1949 is available in the plastic miniDIP, (contact factory for other package options).

### Features

- Low voltage supply (3V–5.5V)
- 22 mA output drive current
- No RFI radiation
- Adaptable to all injector current levels
- Highly accurate operation
- TTL/CMOS compatible input logic levels
- Short circuit protection
- High impedance input
- Externally set holding current,  $I_H$
- Internally set peak current ( $4 \times I_H$ )
- Externally set time-out
- Can be modified for full switching operation
- Available in plastic 8-pin miniDIP

### Applications

- Fuel injection
- Throttle body injection
- Solenoid controls
- Air and fluid valves
- DC motor drives

### Typical Application Circuit

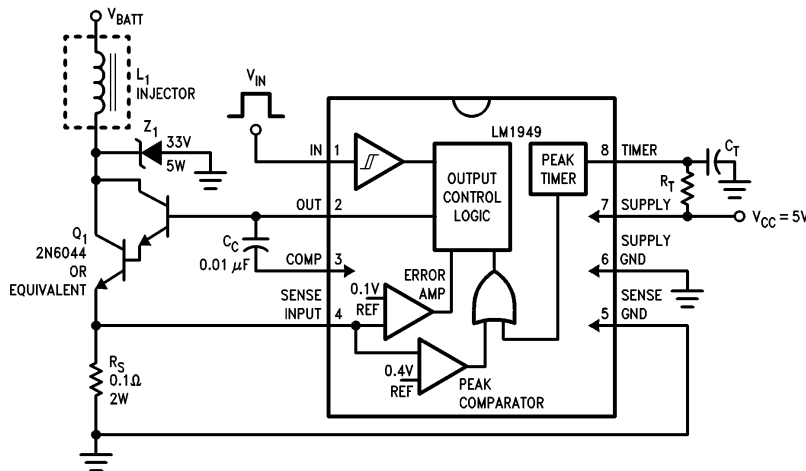

FIGURE 1. Typical Application and Test Circuit

Order Number LM1949M or LM1949N  
See NS Package Number M08A or N08E

TL/H/5062-1

## Absolute Maximum Ratings

If Military/Aerospace specified devices are required, please contact the National Semiconductor Sales Office/Distributors for availability and specifications.

Supply Voltage 8V  
Power Dissipation (Note 1) 1235 mW

Input Voltage Range -0.3V to  $V_{CC}$   
Operating Temperature Range -40°C to +125°C  
Storage Temperature Range -65°C to +150°C  
Junction Temperature 150°C  
Lead Temp. (Soldering 10 sec.) 260°C

## Electrical Characteristics ( $V_{CC}=5.5V$ , $V_{IN}=2.4V$ , $T_J=25^\circ C$ , Figure 1, unless otherwise specified.)

Symbol	Parameter	Conditions	Min	Typ	Max	Units
$I_{CC}$	Supply Current					
	Off	$V_{IN} = 0V$		11	23	mA
	Peak	Pin 8 = 0V		28	54	mA
	Hold	Pin 8 Open		16	26	mA
$V_{OH}$	Input On Level	$V_{CC} = 5.5V$		1.4	2.4	V
		$V_{CC} = 3.0V$		1.2	1.6	V
$V_{OL}$	Input Off Level	$V_{CC} = 5.5V$	1.0	1.35		V
		$V_{CC} = 3.0V$	0.7	1.15		V
$I_B$	Input Current		-25	3	+25	$\mu A$
$I_{OP}$	Output Current					
	Peak	Pin 8 = 0V	-10	-22		mA
	Hold	Pin 8 Open	-1.5	-5		mA
$V_S$	Output Saturation Voltage	10 mA, $V_{IN} = 0V$		0.2	0.4	V
$V_P$	Sense Input	$V_{CC} = 4.75V$				
$V_H$	Hold Reference		88	94	102	mV
t	Time-out, t	$t \div R_T C_T$	90	100	110	%

NOTE 1: For operation in ambient temperatures above 25°C, the device must be derated based on a 150°C maximum junction temperature and a thermal resistance of 100°C/W junction to ambient.

## Typical Circuit Waveforms

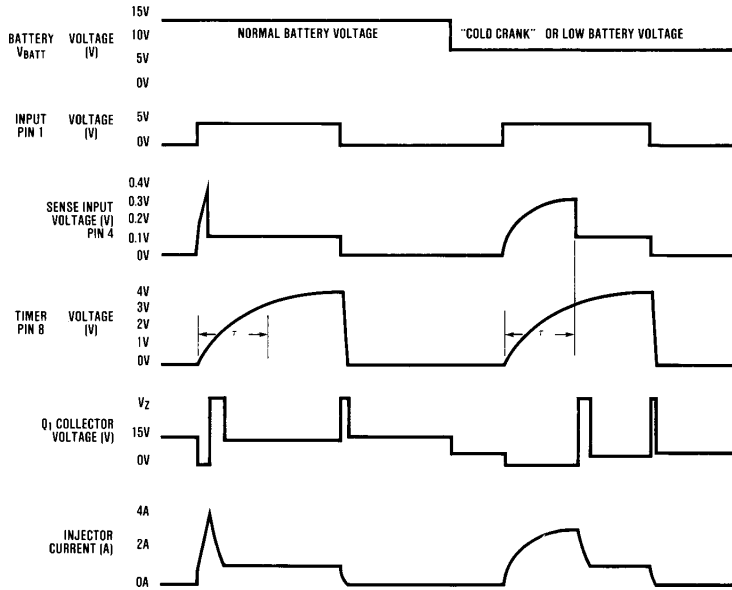

TL/H/5062-2

# Schematic Diagram

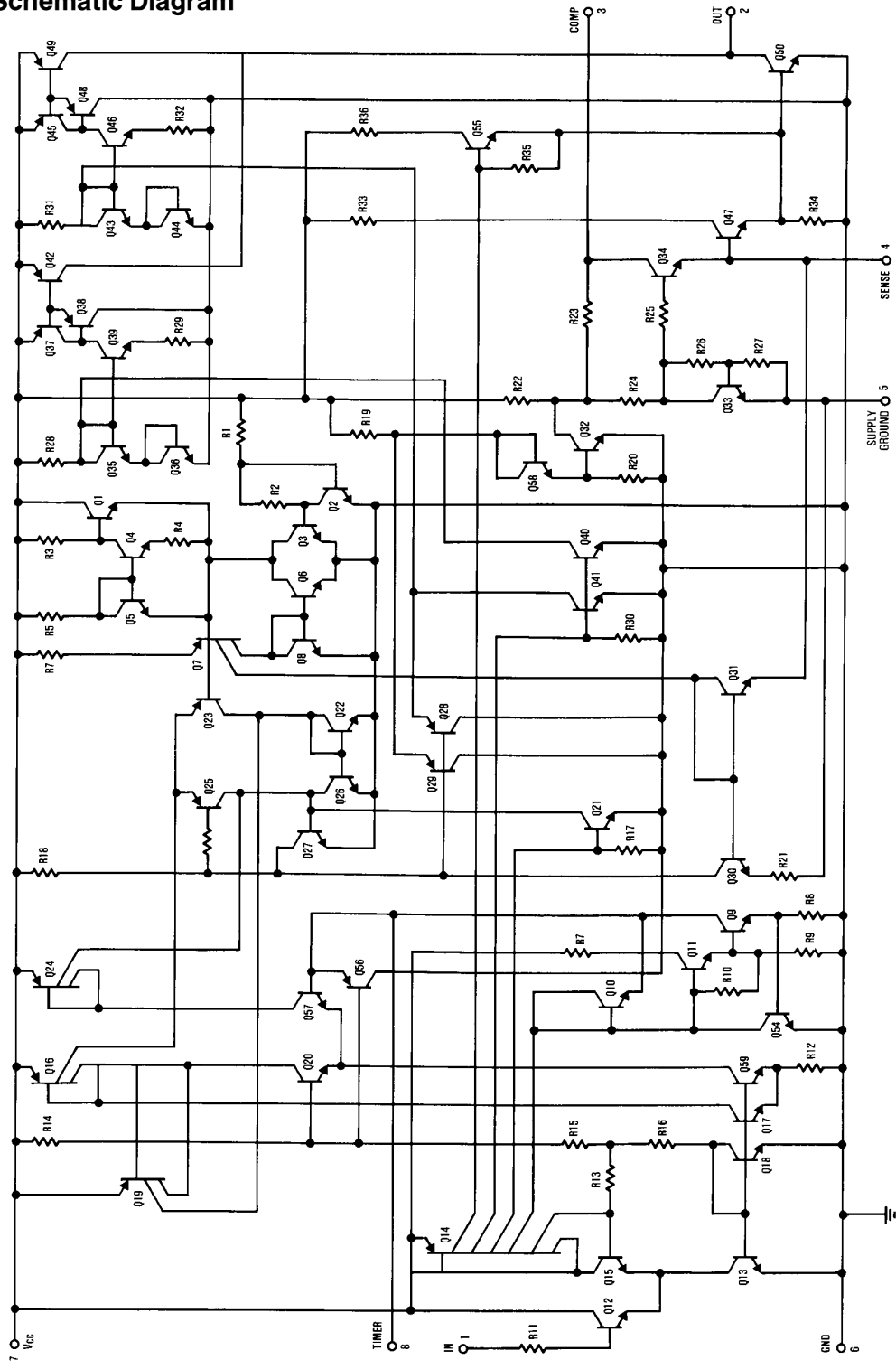

TL/H/5062-3

FIGURE 2. LM1949 Circuit

# Typical Performance Characteristics

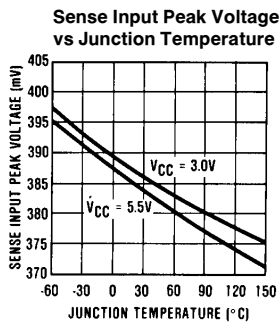
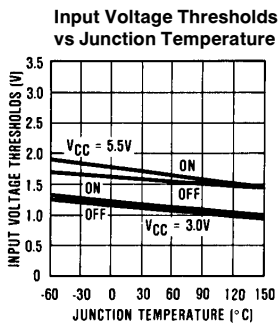
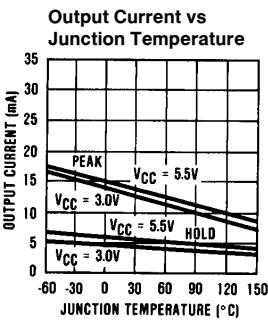
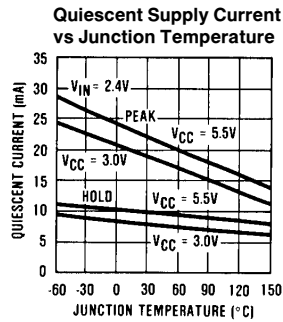
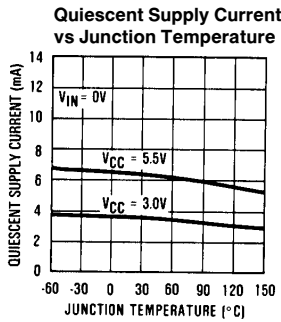
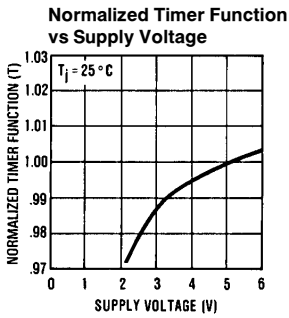
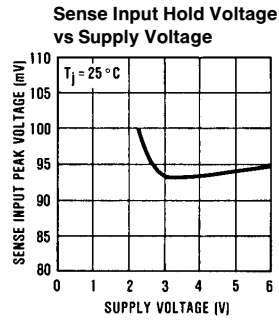
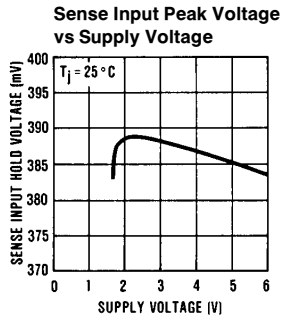
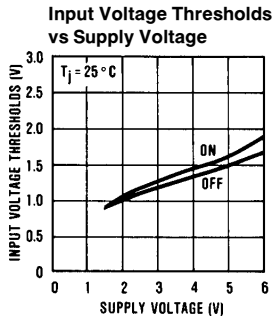
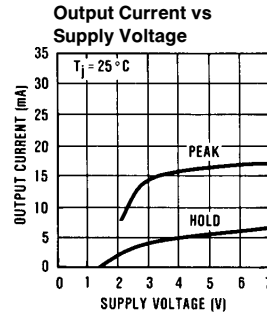
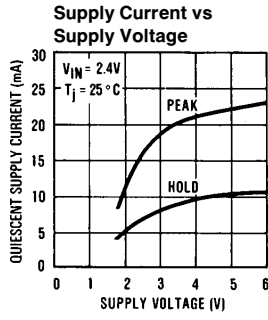
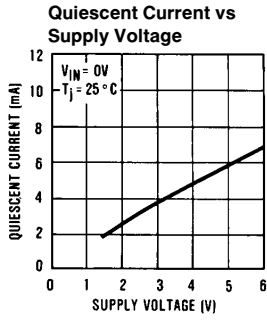

TL/H/5062-4

## Typical Performance Characteristics (Continued)

**Sense Input Hold Voltage vs Junction Temperature**

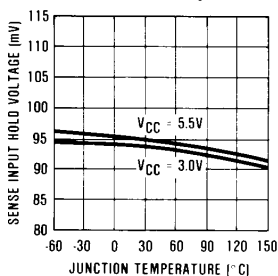

**Normalized Timer Function vs Junction Temperature**

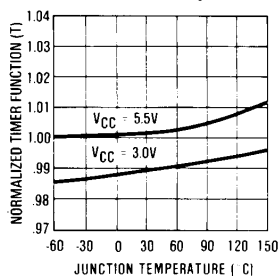

**LM1949N Junction Temperature Rise Above Ambient vs Supply Voltage**

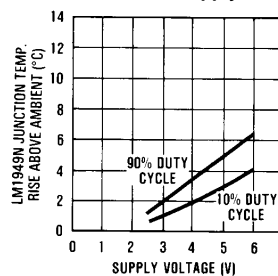

TL/H/5062-5

## Application Hints

The injector driver integrated circuits were designed to be used in conjunction with an external controller. The LM1949 derives its input signal from either a control oriented processor (COPS™), microprocessor, or some other system. This input signal, in the form of a square wave with a variable duty cycle and/or variable frequency, is applied to Pin 1. In a typical system, input frequency is proportional to engine RPM. Duty cycle is proportional to the engine load. The circuits discussed are suitable for use in either open or closed loop systems. In closed loop systems, the engine exhaust is monitored and the air-to-fuel mixture is varied (via the duty cycle) to maintain a perfect, or stoichiometric, ratio.

### INJECTORS

Injectors and solenoids are available in a vast array of sizes and characteristics. Therefore, it is necessary to be able to design a drive system to suit each type of solenoid. The purpose of this section is to enable any system designer to use and modify the LM1949 and associated circuitry to meet the system specifications.

Fuel injectors can usually be modeled by a simple RL circuit. *Figure 3* shows such a model for a typical fuel injector. In actual operation, the value of  $L_1$  will depend upon the status of the solenoid. In other words,  $L_1$  will change depending

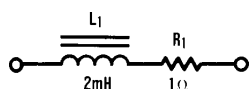

TL/H/5062-6

**FIGURE 3. Model of a Typical Fuel Injector**

upon whether the solenoid is open or closed. This effect, if pronounced enough, can be a valuable aid in determining the current necessary to open a particular type of injector. The change in inductance manifests itself as a breakpoint in the initial rise of solenoid current. The waveforms on Page 2 at the sense input show this occurring at approximately 130 mV. Thus, the current necessary to overcome the constrictive forces of that particular injector is 1.3 amperes.

### PEAK AND HOLD CURRENTS

The peak and hold currents are determined by the value of the sense resistor  $R_S$ . The driver IC, when initiated by a logic 1 signal at Pin 1, initially drives Darlington transistor  $Q_1$  into saturation. The injector current will rise exponentially from zero at a rate dependent upon  $L_1$ ,  $R_1$ , the battery volt-

age and the saturation voltage of  $Q_1$ . The drop across the sense resistor is created by the solenoid current, and when this drop reaches the peak threshold level, typically 385 mV, the IC is tripped from the peak state into the hold state. The IC now behaves more as an op amp and drives  $Q_1$  within a closed loop system to maintain the hold reference voltage, typically 94 mV, across  $R_S$ . Once the injector current drops from the peak level to the hold level, it remains there for the duration of the input signal at Pin 1. This mode of operation is preferable when working with solenoids, since the current required to overcome kinetic and constriction forces is often a factor of four or more times the current necessary to hold the injector open. By holding the injector current at one fourth of the peak current, power dissipation in the solenoids and  $Q_1$  is reduced by at least the same factor.

In the circuit of *Figure 1*, it was known that the type of injector shown opens when the current exceeds 1.3 amps and closes when the current then falls below 0.3 amps. In order to guarantee injector operation over the life and temperature range of the system, a peak current of approximately 4 amps was chosen. This led to a value of  $R_S$  of 0.1Ω. Dividing the peak and hold thresholds by this factor gives peak and hold currents through the solenoid of 3.85 amps and 0.94 amps respectively.

Different types of solenoids may require different values of current. The sense resistor  $R_S$  may be changed accordingly. An 8-amp peak injector would use  $R_S$  equal to .05Ω, etc. Note that for large currents above one amp, IR drops within the component leads or printed circuit board may create substantial errors unless appropriate care is taken. The sense input and sense ground leads (Pins 4 and 5 respectively), should be Kelvin connected to  $R_S$ . High current should not be allowed to flow through any part of these traces or connections. An easy solution to this problem on double-sided PC boards (without plated-through holes) is to have the high current trace and sense trace attach to the  $R_S$  lead from opposite sides of the board.

### TIMER FUNCTION

The purpose of the timer function is to limit the power dissipated by the injector or solenoid under certain conditions. Specifically, when the battery voltage is low due to engine cranking, or just undercharged, there may not be sufficient voltage available for the injector to achieve the peak current. In the *Figure 2* waveforms under the low battery condition, the injector current can be seen to be leveling out at 3

## Timer Function (Continued)

amps, or 1 amp below the normal threshold. Since continuous operation at 3 amps may overheat the injectors, the timer function on the IC will force the transition into the hold state after one time constant (the time constant is equal to  $R_T C_T$ ). The timer is reset at the end of each input pulse. For systems where the timer function is not needed, it can be disabled by grounding Pin 8. For systems where the initial peak state is not required, (i.e., where the solenoid current rises immediately to the hold level), the timer can be used to disable the peak function. This is done by setting the time constant equal to zero, (i.e.,  $C_T = 0$ ). Leaving  $R_T$  in place is recommended. The timer will then complete its time-out and disable the peak condition before the solenoid current has had a chance to rise above the hold level.

The actual range of the timer in injection systems will probably never vary much from the 3.9 milliseconds shown in Figure 1. However, the actual useful range of the timer extends from microseconds to seconds, depending on the component values chosen. The useful range of  $R_T$  is approximately 1k to 240k. The capacitor  $C_T$  is limited only by stray capacitances for low values and by leakages for large values.

The capacitor reset time at the end of each controller pulse is determined by the supply voltage and the capacitor value. The IC resets the capacitor to an initial voltage ( $V_{BE}$ ) by discharging it with a current of approximately 15 mA. Thus, a 0.1  $\mu\text{F}$  cap is reset in approximately 25  $\mu\text{s}$ .

## COMPENSATION

Compensation of the error amplifier provides stability for the circuit during the hold state. External compensation (from Pin 2 to Pin 3) allows each design to be tailored for the characteristics of the system and/or type of Darlington power device used. In the vast majority of designs, the value or type of the compensation capacitor is not critical. Values of 100 pF to 0.1  $\mu\text{F}$  work well with the circuit of Figure 1. The value shown of .01  $\mu\text{F}$  (disc) provides a close optimum in choice between economy, speed, and noise immunity. In some systems, increased phase and gain margin may be acquired by bypassing the collector of  $Q_1$  to ground with an appropriately rated 0.1  $\mu\text{F}$  capacitor. This is, however, rarely necessary.

## FLYBACK ZENER

The purpose of zener  $Z_1$  is twofold. Since the load is inductive, a voltage spike is produced at the collector of  $Q_1$  any time the injector current is reduced. This occurs at the peak-to-hold transition, (when the current is reduced to one fourth of its peak value), and also at the end of each input pulse, (when the current is reduced to zero). The zener provides a current path for the inductive kickback, limiting the voltage spike to the zener value and preventing  $Q_1$  from damaging voltage levels. Thus, the rated zener voltage at the system peak current must be less than the guaranteed minimum breakdown of  $Q_1$ . Also, even while  $Z_1$  is conducting the majority of the injector current during the peak-to-hold transition (see Figure 4),  $Q_1$  is operating at the hold current level. This fact is easily overlooked and, as described in the following text, can be corrected if necessary. Since the error amplifier in the IC demands 94 mV across  $R_S$ ,  $Q_1$  will be biased to provide exactly that. Thus, the safe operating area (SOA) of  $Q_1$  must include the hold current with a  $V_{CE}$  of  $Z_1$  volts. For systems where this is not desired, the zener anode may be reconnected to the top of  $R_S$  as shown in Figure 5. Since the voltage across the sense resistor now accurately portrays the injector current at all times, the error

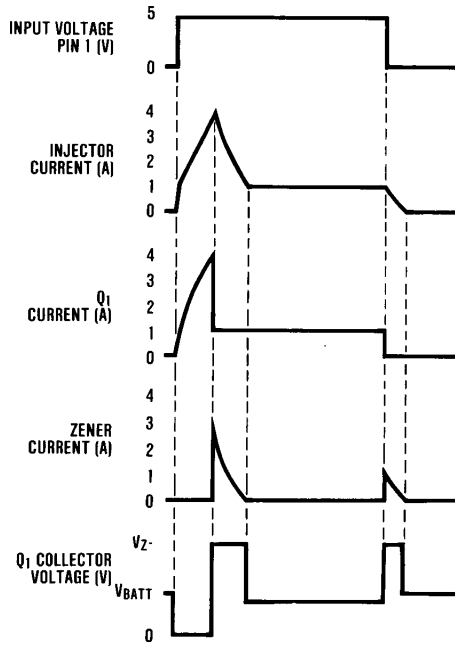

TL/H/5062-7

FIGURE 4. Circuit Waveforms

amplifier keeps  $Q_1$  off until the injector current has decayed to the proper value. The disadvantage of this particular configuration is that the ungrounded zener is more difficult to heat sink if that becomes necessary.

The second purpose of  $Z_1$  is to provide system transient protection. Automotive systems are susceptible to a vast array of voltage transients on the battery line. Though their duration is usually only milliseconds long,  $Q_1$  could suffer permanent damage unless buffered by the injector and  $Z_1$ . This is one reason why a zener is preferred over a clamp diode back to the battery line, the other reason being long decay times.

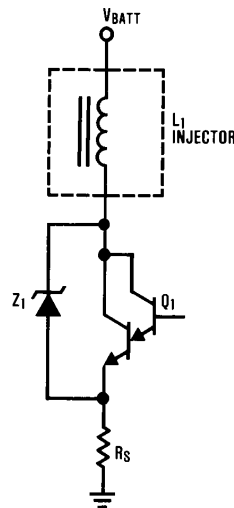

TL/H/5062-8

FIGURE 5. Alternate Configuration for Zener  $Z_1$

## POWER DISSIPATION

The power dissipation of the system shown in *Figure 1* is dependent upon several external factors, including the frequency and duty cycle of the input waveform to Pin 1. Calculations are made more difficult since there are many discontinuities and breakpoints in the power waveforms of the various components, most notably at the peak-to-hold transition. Some generalizations can be made for normal operation. For example, in a typical cycle of operation, the majority of dissipation occurs during the hold state. The hold state is usually much longer than the peak state, and in the peak state nearly all power is stored as energy in the magnetic field of the injector, later to be dumped mostly through the zener. While this assumption is less accurate in the case of low battery voltage, it nevertheless gives an unexpectedly accurate set of approximations for general operation.

The following nomenclature refers to *Figure 1*. Typical values are given in parentheses:

- $R_S$  = Sense Resistor (0.1 $\Omega$ )
- $V_H$  = Sense Input Hold Voltage (.094V)
- $V_p$  = Sense Input Peak Voltage (.385V)
- $V_Z$  =  $Z_1$  Zener Breakdown Voltage (33V)
- $V_{BATT}$  = Battery Voltage (14V)
- $L_1$  = Injector Inductance (.002H)
- $R_1$  = Injector Resistance (1 $\Omega$ )
- $n$  = Duty Cycle of Input Voltage of Pin 1 (0 to 1)
- $f$  = Frequency of Input (10Hz to 200Hz)

$Q_1$  Power Dissipation:

$$P_Q \approx n \cdot V_{BATT} \cdot \frac{V_H}{R_S} \text{ Watts}$$

Zener Dissipation:

$$P_Z \approx V_Z \cdot L_1 \cdot f \cdot \frac{(V_p^2 + V_H^2)}{(V_Z - V_{BATT}) \cdot R_S^2} \text{ Watts}$$

Injector Dissipation:

$$P_I \approx n \cdot R_1 \cdot \frac{V_H^2}{R_S^2} \text{ Watts}$$

Sense Resistor:

$$P_R \approx n \frac{V_H^2}{R_S^2} \text{ Watts}$$

$$P_R \text{ (worst case)} \approx n \frac{V_p^2}{R_S^2} \text{ Watts}$$

## SWITCHING INJECTOR DRIVER CIRCUIT

The power dissipation of the system, and especially of  $Q_1$ , can be reduced by employing a switching injector driver circuit. Since the injector load is mainly inductive, transistor  $Q_1$  can be rapidly switched on and off in a manner similar to switching regulators. The solenoid inductance will naturally integrate the voltage to produce the required injector current, while the power consumed by  $Q_1$  will be reduced. A note of caution: The large amplitude switching voltages that are present on the injector can and do generate a tremendous amount of radio frequency interference (RFI). Because of this, switching circuits are not recommended. The extra cost of shielding can easily exceed the savings of reduced power. In systems where switching circuits are mandatory, extensive field testing is required to guarantee that RFI cannot create problems with engine control or entertainment equipment within the vicinity.

The LM1949 can be easily modified to function as a switcher. Accomplished with the circuit of *Figure 7*, the only additional components required are two external resistors,  $R_A$  and  $R_B$ . Additionally, the zener needs to be reconnected, as shown, to  $R_S$ . The amount of ripple on the hold current is easily controlled by the resistor ratio of  $R_A$  to  $R_B$ .  $R_B$  is kept small so that sense input bias current (typically 0.3 mA) has negligible effect on  $V_H$ . Duty cycle and frequency of oscillation during the hold state are dependent on the injector characteristics,  $R_A$ ,  $R_B$ , and the zener voltage as shown in the following equations.

$$\text{Hold Current} \approx \frac{V_H}{R_S}$$

$$\text{Minimum Hold Current} \approx \frac{\left( V_H - \frac{R_B}{R_A} \cdot V_Z \right)}{R_S}$$

$$\text{Ripple or } \Delta I \text{ Hold} \approx \frac{R_B}{R_A} \cdot V_Z \cdot \frac{1}{R_S}$$

$$f_o \approx \frac{R_S}{L_1} \cdot \frac{R_A}{R_B} \cdot \frac{V_{BATT}}{V_Z} \cdot \left( 1 - \frac{V_{BATT}}{V_Z} \right)$$

$f_o$  = Hold State Oscillation Frequency

$$\text{Duty Cycle of } f_o \approx \frac{V_{BATT}}{V_Z}$$

Component Power Dissipation

$$P_Q \approx n \cdot \left( 1 - \frac{V_{BATT}}{V_Z} \right) \cdot \frac{V_{SAT}}{R_S} \cdot V_H$$

$V_{SAT}$  =  $Q_1$  Saturation Volt @ ~ 1 Amp (1.5V)

$$P_Z \approx n \cdot \frac{V_{BATT} \cdot V_H}{R_S}$$

$$P_{RA} \approx \frac{V_B \cdot V_Z}{R_1}$$

As shown, the power dissipation by  $Q_1$  in this manner is substantially reduced. Measurements made with a thermocouple on the bench indicated better than a fourfold reduction in power in  $Q_1$ . However, the power dissipation of the zener (which is independent of the zener voltage chosen) is increased over the circuit of *Figure 1*.

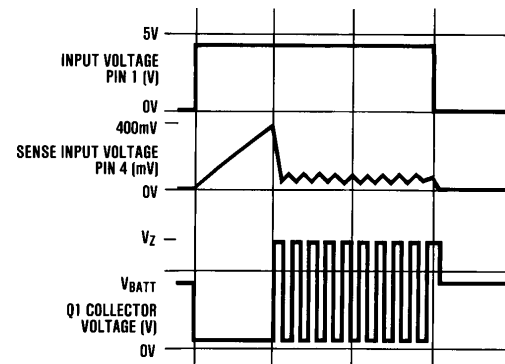

FIGURE 6. Switching Waveforms

TL/H/5062-9

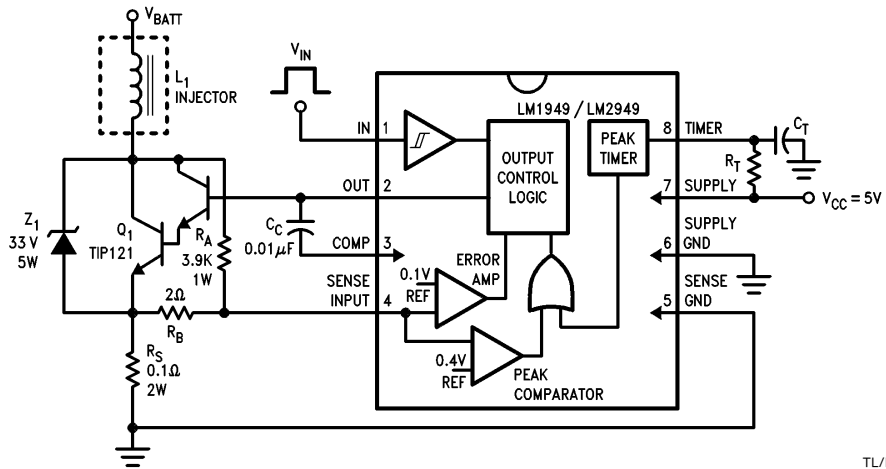

FIGURE 7. Switching Application Circuit

TL/H/5062-10





**Physical Dimensions** inches (millimeters) (Continued)

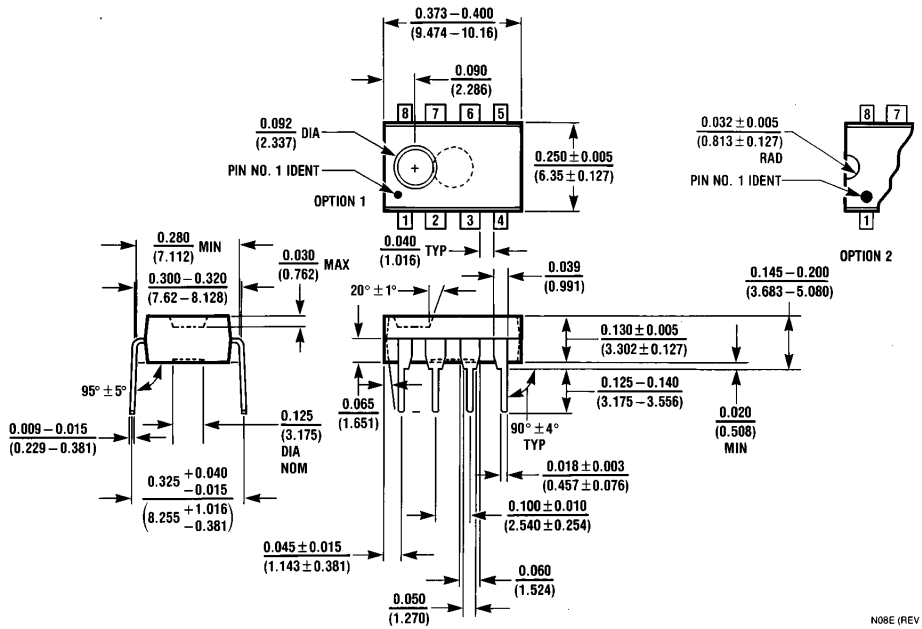

**Molded Dual-In-Line Package (N)**  
**Order Number LM1949N**  
**NS Package Number N08E**

N08E (REV F)

**LIFE SUPPORT POLICY**

NATIONAL'S PRODUCTS ARE NOT AUTHORIZED FOR USE AS CRITICAL COMPONENTS IN LIFE SUPPORT DEVICES OR SYSTEMS WITHOUT THE EXPRESS WRITTEN APPROVAL OF THE PRESIDENT OF NATIONAL SEMICONDUCTOR CORPORATION. As used herein:

1. Life support devices or systems are devices or systems which, (a) are intended for surgical implant into the body, or (b) support or sustain life, and whose failure to perform, when properly used in accordance with instructions for use provided in the labeling, can be reasonably expected to result in a significant injury to the user.
2. A critical component is any component of a life support device or system whose failure to perform can be reasonably expected to cause the failure of the life support device or system, or to affect its safety or effectiveness.



**National Semiconductor Corporation**  
 1111 West Bardin Road  
 Arlington, TX 76017  
 Tel: 1(800) 272-9959  
 Fax: 1(800) 737-7018

**National Semiconductor Europe**  
 Fax: (+49) 0-180-530 85 86  
 Email: cnjwge@tevm2.nsc.com  
 Deutsch Tel: (+49) 0-180-530 85 85  
 English Tel: (+49) 0-180-532 78 32  
 Français Tel: (+49) 0-180-532 93 58  
 Italiano Tel: (+49) 0-180-534 16 80

**National Semiconductor Hong Kong Ltd.**  
 19th Floor, Straight Block,  
 Ocean Centre, 5 Canton Rd.  
 Tsimshatsui, Kowloon  
 Hong Kong  
 Tel: (852) 2737-1600  
 Fax: (852) 2736-9960

**National Semiconductor Japan Ltd.**  
 Tel: 81-043-299-2309  
 Fax: 81-043-299-2408

National does not assume any responsibility for use of any circuitry described, no circuit patent licenses are implied and National reserves the right at any time without notice to change said circuitry and specifications.