

IRF5210PbF

HEXFET® Power MOSFET

- Advanced Process Technology
- Ultra Low On-Resistance
- Dynamic dv/dt Rating
- 175°C Operating Temperature
- Fast Switching
- P-Channel
- Fully Avalanche Rated
- Lead-Free

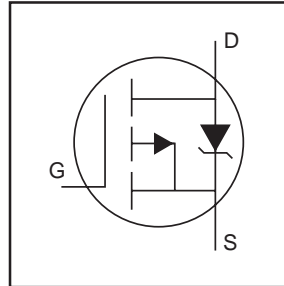

$V_{DS} = -100V$
$R_{DS(on)} = 0.06\Omega$
$I_D = -40A$

Description

Fifth Generation HEXFETs from International Rectifier utilize advanced processing techniques to achieve extremely low on-resistance per silicon area. This benefit, combined with the fast switching speed and ruggedized device design that HEXFET Power MOSFETs are well known for, provides the designer with an extremely efficient and reliable device for use in a wide variety of applications.

The TO-220 package is universally preferred for all commercial-industrial applications at power dissipation levels to approximately 50 watts. The low thermal resistance and low package cost of the TO-220 contribute to its wide acceptance throughout the industry.

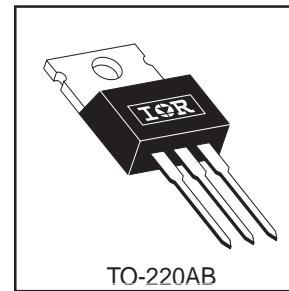

Absolute Maximum Ratings

	Parameter	Max.	Units
$I_D @ T_C = 25^\circ C$	Continuous Drain Current, $V_{GS} @ -10V$	-40	A
$I_D @ T_C = 100^\circ C$	Continuous Drain Current, $V_{GS} @ -10V$	-29	
I_{DM}	Pulsed Drain Current $\text{\textcircled{D}}$	-140	
$P_D @ T_C = 25^\circ C$	Power Dissipation	200	W
	Linear Derating Factor	1.3	W/°C
V_{GS}	Gate-to-Source Voltage	± 20	V
E_{AS}	Single Pulse Avalanche Energy $\text{\textcircled{A}}$	780	mJ
I_{AR}	Avalanche Current $\text{\textcircled{A}}$	-21	A
E_{AR}	Repetitive Avalanche Energy $\text{\textcircled{A}}$	20	mJ
dv/dt	Peak Diode Recovery dv/dt $\text{\textcircled{D}}$	-5.0	V/ns
T_J	Operating Junction and	-55 to + 175	°C
T_{STG}	Storage Temperature Range		
	Soldering Temperature, for 10 seconds		
	Mounting torque, 6-32 or M3 screw	10 lbf•in (1.1N•m)	

Thermal Resistance

	Parameter	Typ.	Max.	Units
$R_{\theta JC}$	Junction-to-Case	---	0.75	°C/W
$R_{\theta CS}$	Case-to-Sink, Flat, Greased Surface	0.50	---	
$R_{\theta JA}$	Junction-to-Ambient	---	62	

IRF5210PbF

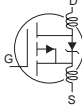

Electrical Characteristics @ T_J = 25°C (unless otherwise specified)

	Parameter	Min.	Typ.	Max.	Units	Conditions
V _{(BR)DSS}	Drain-to-Source Breakdown Voltage	-100	—	—	V	V _{GS} = 0V, I _D = -250μA
ΔV _{(BR)DSS} /ΔT _J	Breakdown Voltage Temp. Coefficient	—	-0.11	—	V/°C	Reference to 25°C, I _D = -1mA
R _{DSON}	Static Drain-to-Source On-Resistance	—	—	0.06	Ω	V _{GS} = -10V, I _D = -24A ④
V _{GS(th)}	Gate Threshold Voltage	-2.0	—	-4.0	V	V _{DS} = V _{GS} , I _D = -250μA
g _{fs}	Forward Transconductance	10	—	—	S	V _{DS} = -50V, I _D = -21A
I _{DSS}	Drain-to-Source Leakage Current	—	—	-25	μA	V _{DS} = -100V, V _{GS} = 0V
		—	—	-250		V _{DS} = -80V, V _{GS} = 0V, T _J = 150°C
I _{GSS}	Gate-to-Source Forward Leakage	—	—	100	nA	V _{GS} = 20V
	Gate-to-Source Reverse Leakage	—	—	-100		V _{GS} = -20V
Q _g	Total Gate Charge	—	—	180	nC	I _D = -21A
Q _{gs}	Gate-to-Source Charge	—	—	25		V _{DS} = -80V
Q _{gd}	Gate-to-Drain ("Miller") Charge	—	—	97		V _{GS} = -10V, See Fig. 6 and 13 ④
t _{d(on)}	Turn-On Delay Time	—	17	—	ns	V _{DD} = -50V
t _r	Rise Time	—	86	—		I _D = -21A
t _{d(off)}	Turn-Off Delay Time	—	79	—		R _G = 2.5Ω
t _f	Fall Time	—	81	—		R _D = 2.4Ω, See Fig. 10 ④
L _D	Internal Drain Inductance	—	4.5	—	nH	Between lead, 6mm (0.25in.) from package and center of die contact
L _S	Internal Source Inductance	—	7.5	—		
C _{iss}	Input Capacitance	—	2700	—	pF	V _{GS} = 0V
C _{oss}	Output Capacitance	—	790	—		V _{DS} = -25V
C _{rss}	Reverse Transfer Capacitance	—	450	—		f = 1.0MHz, See Fig. 5

Source-Drain Ratings and Characteristics

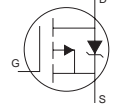
	Parameter	Min.	Typ.	Max.	Units	Conditions
I _S	Continuous Source Current (Body Diode)	—	—	-40	A	MOSFET symbol showing the integral reverse p-n junction diode. 
I _{SM}	Pulsed Source Current (Body Diode) ①	—	—	-140		
V _{SD}	Diode Forward Voltage	—	—	-1.6	V	T _J = 25°C, I _S = -21A, V _{GS} = 0V ④
t _{rr}	Reverse Recovery Time	—	170	260	ns	T _J = 25°C, I _F = -21A
Q _{rr}	Reverse Recovery Charge	—	1.2	1.8	μC	di/dt = -100A/μs ④
t _{on}	Forward Turn-On Time	Intrinsic turn-on time is negligible (turn-on is dominated by L _S +L _D)				

Notes:

- ① Repetitive rating; pulse width limited by max. junction temperature. (See fig. 11)
- ② V_{DD} = -25V, starting T_J = 25°C, L = 3.5mH
R_G = 25Ω, I_{AS} = -21A. (See Figure 12)
- ③ I_{SD} ≤ -21A, di/dt ≤ -480A/μs, V_{DD} ≤ V_{(BR)DSS},
T_J ≤ 175°C
- ④ Pulse width ≤ 300μs; duty cycle ≤ 2%.



IRF5210PbF

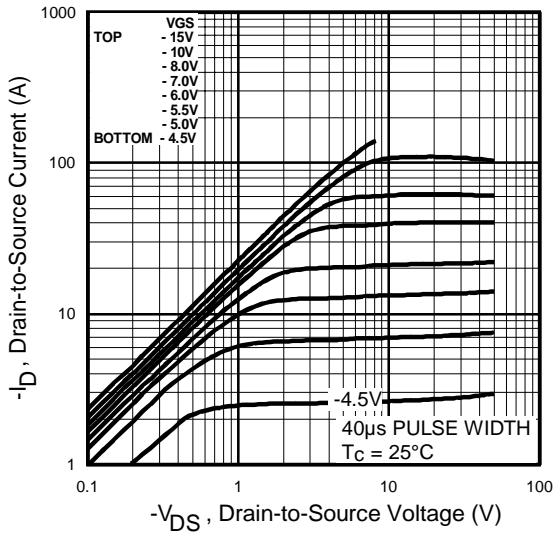

Fig 1. Typical Output Characteristics

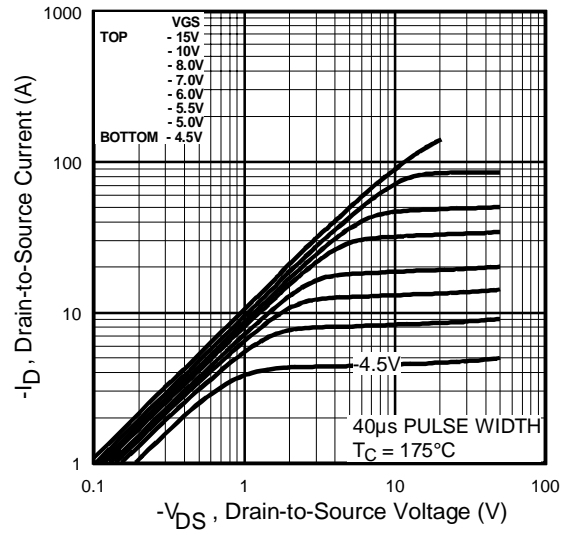

Fig 2. Typical Output Characteristics

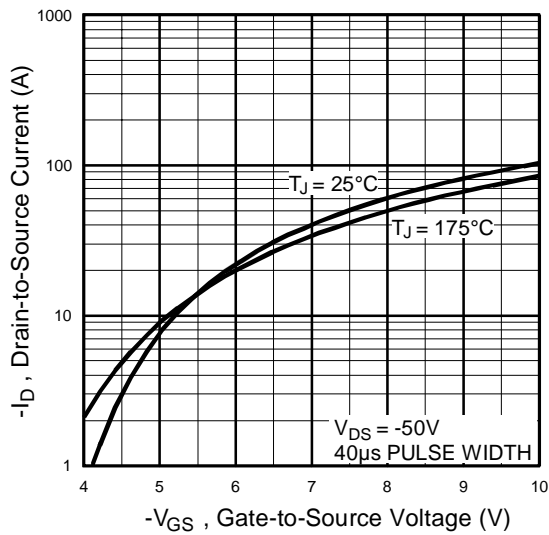

Fig 3. Typical Transfer Characteristics

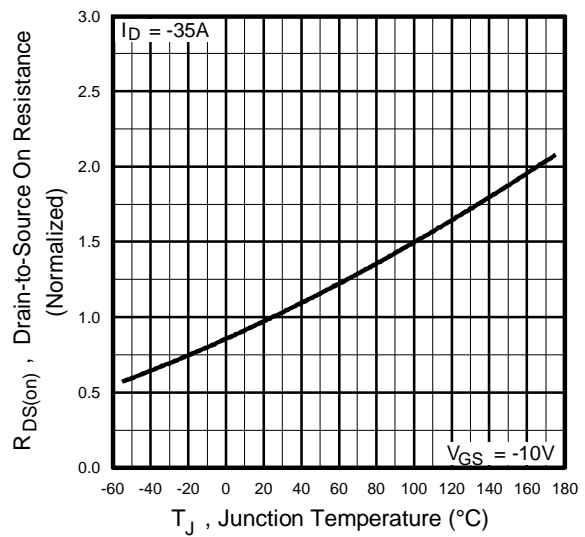

Fig 4. Normalized On-Resistance Vs. Temperature

IRF5210PbF

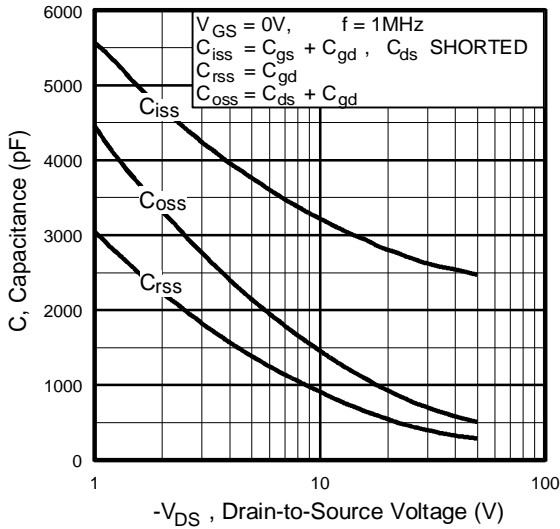

Fig 5. Typical Capacitance Vs. Drain-to-Source Voltage

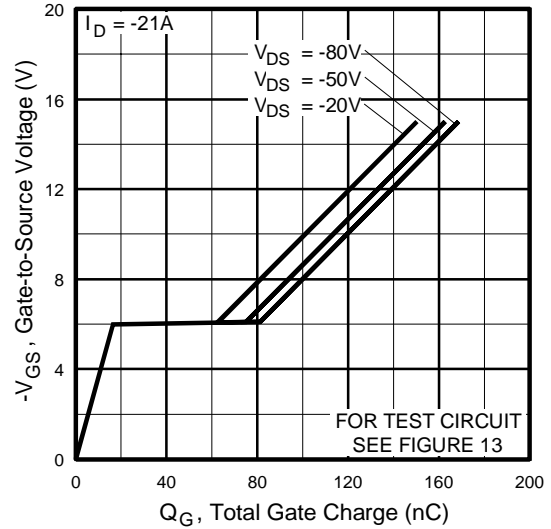

Fig 6. Typical Gate Charge Vs. Gate-to-Source Voltage

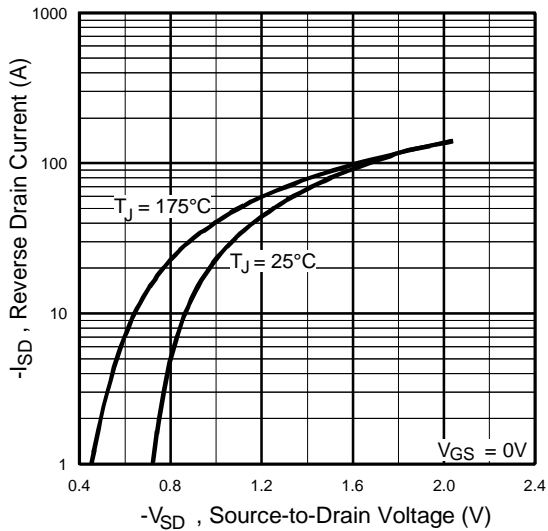

Fig 7. Typical Source-Drain Diode Forward Voltage

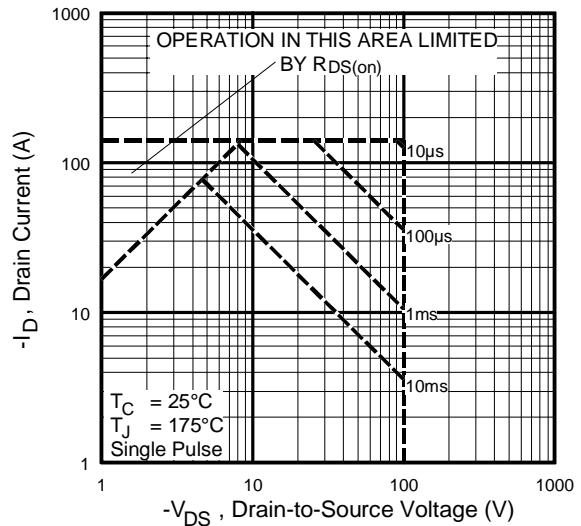

Fig 8. Maximum Safe Operating Area



IRF5210PbF

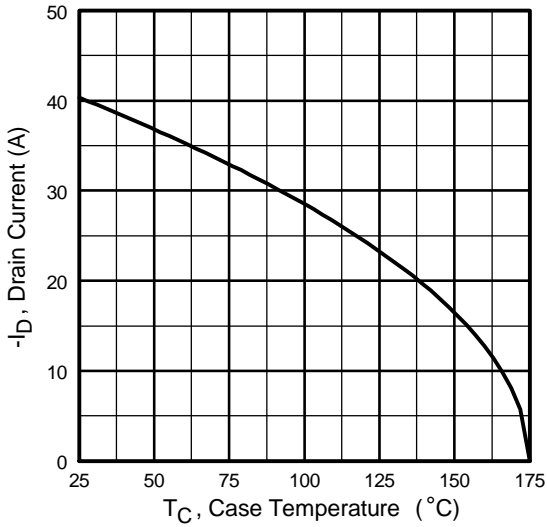

Fig 9. Maximum Drain Current Vs. Case Temperature

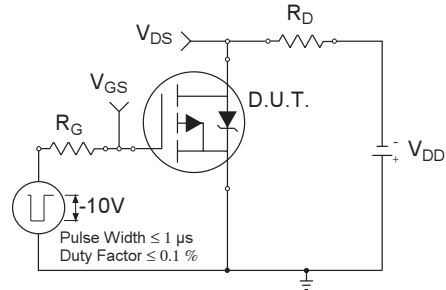

Fig 10a. Switching Time Test Circuit

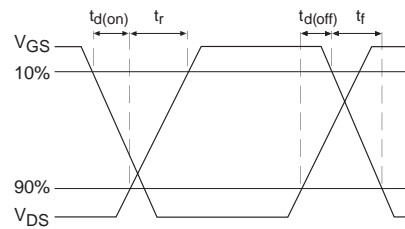

Fig 10b. Switching Time Waveforms

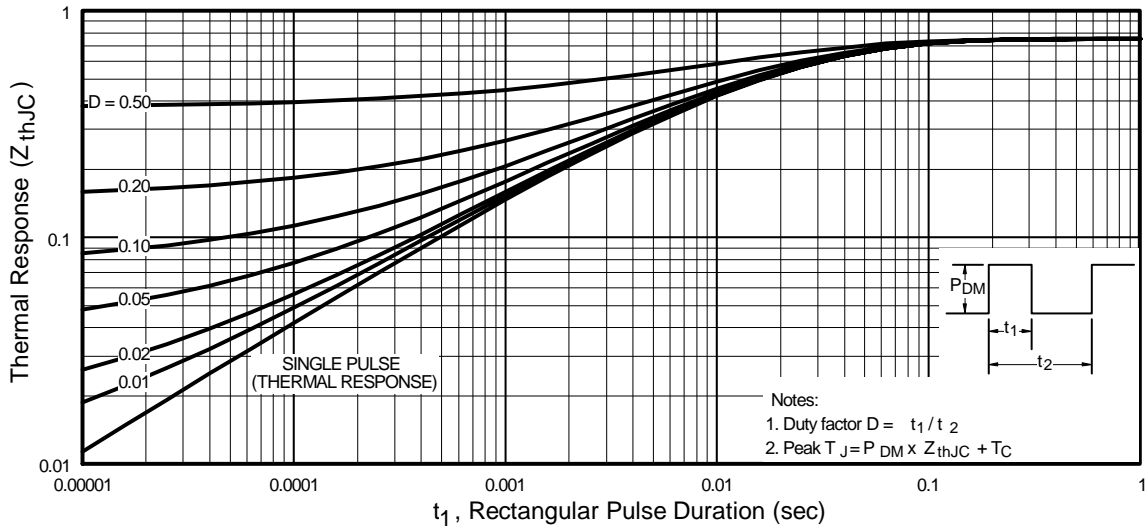

Fig 11. Maximum Effective Transient Thermal Impedance, Junction-to-Case

IRF5210PbF

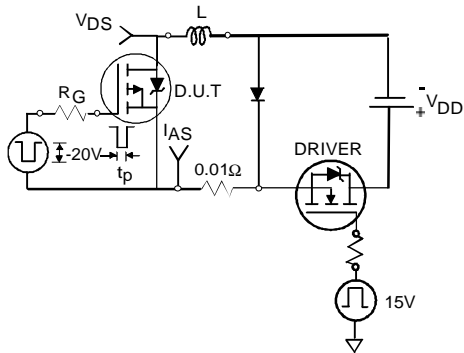

Fig 12a. Unclamped Inductive Test Circuit

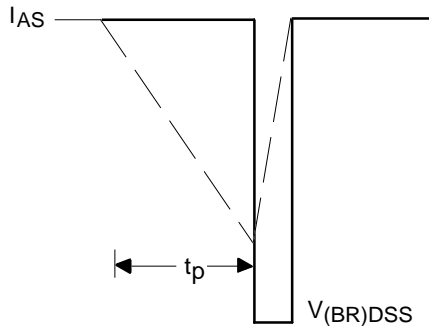

Fig 12b. Unclamped Inductive Waveforms

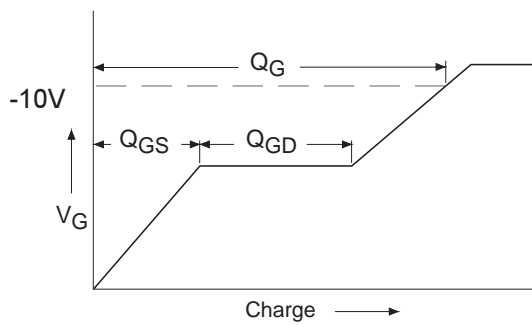

Fig 13a. Basic Gate Charge Waveform

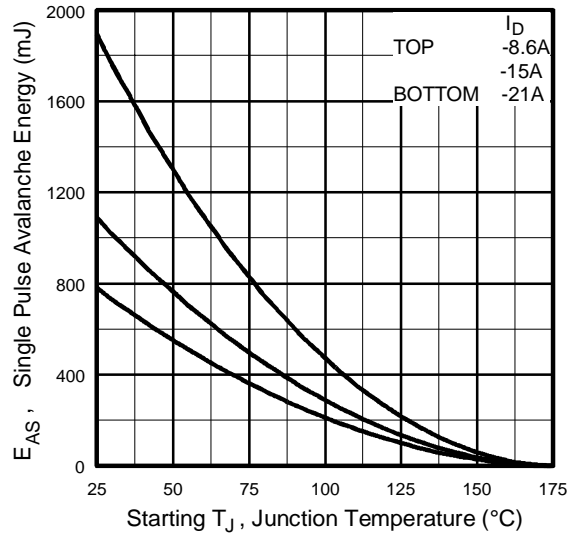

Fig 12c. Maximum Avalanche Energy Vs. Drain Current

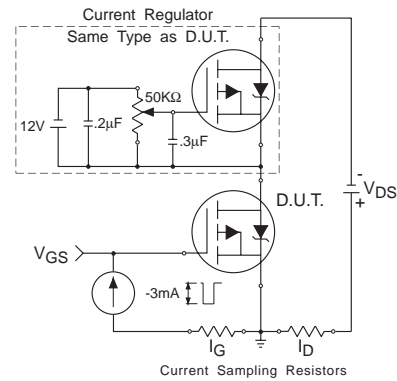
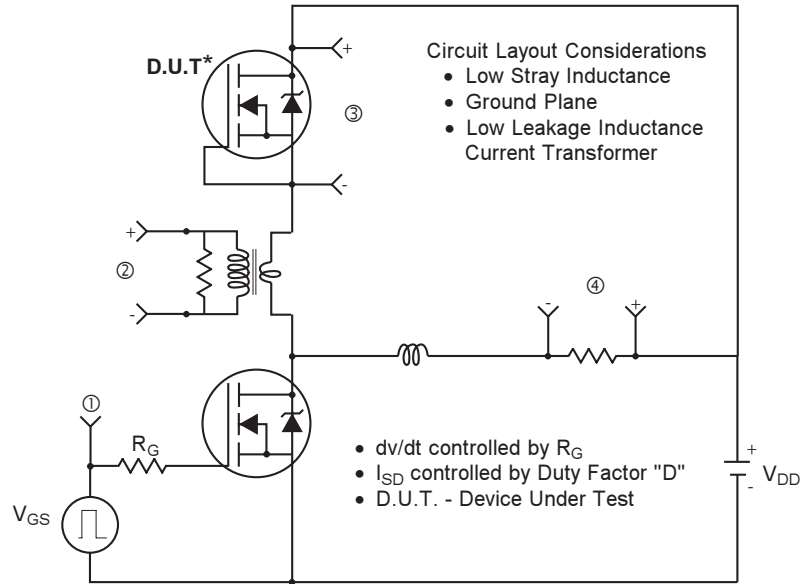

Fig 13b. Gate Charge Test Circuit



IRF5210PbF

Peak Diode Recovery dv/dt Test Circuit



* Reverse Polarity of D.U.T for P-Channel

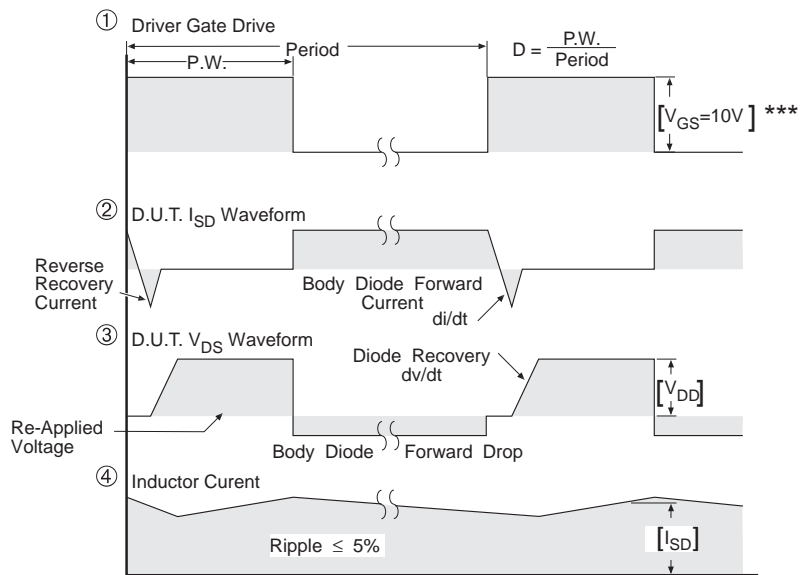

*** $V_{GS} = 5.0V$ for Logic Level and 3V Drive Devices

Fig 14. For P-Channel HEXFETS

IRF5210PbF



TO-220AB Package Outline

Dimensions are shown in millimeters (inches)

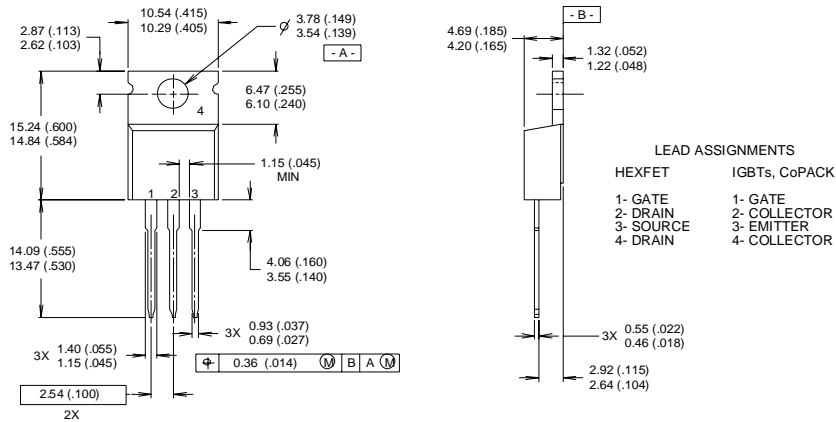

- NOTES:
- 1 DIMENSIONING & TOLERANCING PER ANSI Y14.5M, 1982.
 - 2 CONTROLLING DIMENSION : INCH
 - 3 OUTLINE CONFORMS TO JEDEC OUTLINE TO-220AB.
 - 4 HEATSINK & LEAD MEASUREMENTS DO NOT INCLUDE BURRS.

TO-220AB Part Marking Information

EXAMPLE: THIS IS AN IRF1010
 LOT CODE 1789
 ASSEMBLED ON WW 19, 1997
 IN THE ASSEMBLY LINE "C"
Note: "P" in assembly line position indicates "Lead-Free"

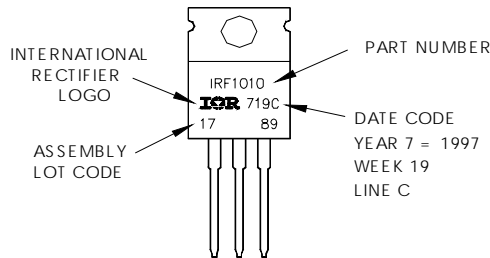

Data and specifications subject to change without notice.

International
IR Rectifier

IR WORLD HEADQUARTERS: 233 Kansas St., El Segundo, California 90245, USA Tel: (310) 252-7105
 TAC Fax: (310) 252-7903

Visit us at www.irf.com for sales contact information. 06/04

Note: For the most current drawings please refer to the IR website at:
<http://www.irf.com/package/>

Mouser Electronics

Authorized Distributor

Click to View Pricing, Inventory, Delivery & Lifecycle Information:

[International Rectifier:](#)

[IRF5210PBF](#)