

# FGA25N120ANTD

## 1200 V, 25 A NPT Trench IGBT

### Features

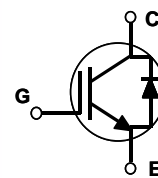
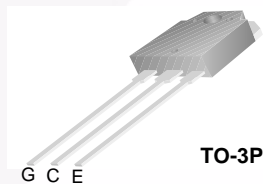
- NPT Trench Technology, Positive Temperature Coefficient
- Low Saturation Voltage:  $V_{CE(sat), typ} = 2.0\text{ V}$   
@  $I_C = 25\text{ A}$  and  $T_C = 25^\circ\text{C}$
- Low Switching Loss:  $E_{off, typ} = 0.96\text{ mJ}$   
@  $I_C = 25\text{ A}$  and  $T_C = 25^\circ\text{C}$
- Extremely Enhanced Avalanche Capability

### Description

Using Fairchild's proprietary trench design and advanced NPT technology, the 1200V NPT IGBT offers superior conduction and switching performances, high avalanche ruggedness and easy parallel operation. This device is well suited for the resonant or soft switching application such as induction heating, microwave oven.

### Applications

- Induction Heating, Microwave Oven



### Absolute Maximum Ratings

Symbol	Description	Ratings	Unit
$V_{CES}$	Collector-Emitter Voltage	1200	V
$V_{GES}$	Gate-Emitter Voltage	$\pm 20$	V
$I_C$	Collector Current	@ $T_C = 25^\circ\text{C}$	50
	Collector Current	@ $T_C = 100^\circ\text{C}$	25
$I_{CM(1)}$	Pulsed Collector Current	90	A
$I_F$	Diode Continuous Forward Current	@ $T_C = 25^\circ\text{C}$	50
	Diode Continuous Forward Current	@ $T_C = 100^\circ\text{C}$	25
$I_{FM}$	Diode Maximum Forward Current	150	A
$P_D$	Maximum Power Dissipation	@ $T_C = 25^\circ\text{C}$	312
	Maximum Power Dissipation	@ $T_C = 100^\circ\text{C}$	125
$T_J$	Operating Junction Temperature	-55 to +150	$^\circ\text{C}$
$T_{stg}$	Storage Temperature Range	-55 to +150	$^\circ\text{C}$
$T_L$	Maximum Lead Temp. for soldering Purposes, 1/8" from case for 5 seconds	300	$^\circ\text{C}$

**Notes:**

(1) Repetitive rating: Pulse width limited by max. junction temperature

### Thermal Characteristics

Symbol	Parameter	Typ.	Max.	Unit
$R_{\theta JC}(\text{IGBT})$	Thermal Resistance, Junction-to-Case	--	0.4	$^\circ\text{C/W}$
$R_{\theta JC}(\text{DIODE})$	Thermal Resistance, Junction-to-Case	--	2.0	$^\circ\text{C/W}$
$R_{\theta JA}$	Thermal Resistance, Junction-to-Ambient	--	40	$^\circ\text{C/W}$

## Package Marking and Ordering Information

Part Number	Top Mark	Package	Packing Method	Reel Size	Tape Width	Quantity
FGA25N120ANTDTU	FGA25N120ANTD	TO-3P	Tube	N/A	N/A	30

## Electrical Characteristics of the IGBT T<sub>C</sub> = 25°C unless otherwise noted

Symbol	Parameter	Test Conditions	Min.	Typ.	Max.	Unit
<b>Off Characteristics</b>						
I <sub>CES</sub>	Collector Cut-Off Current	V <sub>CE</sub> = V <sub>CES</sub> , V <sub>GE</sub> = 0 V	--	--	3	mA
I <sub>GES</sub>	G-E Leakage Current	V <sub>GE</sub> = V <sub>GES</sub> , V <sub>CE</sub> = 0 V	--	--	± 250	nA
<b>On Characteristics</b>						
V <sub>GE(th)</sub>	G-E Threshold Voltage	I <sub>C</sub> = 25 mA, V <sub>CE</sub> = V <sub>GE</sub>	3.5	5.5	7.5	V
V <sub>CE(sat)</sub>	Collector to Emitter Saturation Voltage	I <sub>C</sub> = 25 A, V <sub>GE</sub> = 15 V	--	2.0	--	V
		I <sub>C</sub> = 25 A, V <sub>GE</sub> = 15 V, T <sub>C</sub> = 125°C	--	2.15	--	V
		I <sub>C</sub> = 50 A, V <sub>GE</sub> = 15 V	--	2.65	--	V
<b>Dynamic Characteristics</b>						
C <sub>ies</sub>	Input Capacitance	V <sub>CE</sub> = 30 V, V <sub>GE</sub> = 0 V, f = 1 MHz	--	3700	--	pF
C <sub>oes</sub>	Output Capacitance		--	130	--	pF
C <sub>res</sub>	Reverse Transfer Capacitance		--	80	--	pF
<b>Switching Characteristics</b>						
t <sub>d(on)</sub>	Turn-On Delay Time	V <sub>CC</sub> = 600 V, I <sub>C</sub> = 25 A, R <sub>G</sub> = 10 Ω, V <sub>GE</sub> = 15 V, Inductive Load, T <sub>C</sub> = 25°C	--	50	--	ns
t <sub>r</sub>	Rise Time		--	60	--	ns
t <sub>d(off)</sub>	Turn-Off Delay Time		--	190	--	ns
t <sub>f</sub>	Fall Time		--	100	--	ns
E <sub>on</sub>	Turn-On Switching Loss		--	4.1	--	mJ
E <sub>off</sub>	Turn-Off Switching Loss		--	0.96	--	mJ
E <sub>ts</sub>	Total Switching Loss		--	5.06	--	mJ
t <sub>d(on)</sub>	Turn-On Delay Time	V <sub>CC</sub> = 600 V, I <sub>C</sub> = 25 A, R <sub>G</sub> = 10 Ω, V <sub>GE</sub> = 15 V, Inductive Load, T <sub>C</sub> = 125°C	--	50	--	ns
t <sub>r</sub>	Rise Time		--	60	--	ns
t <sub>d(off)</sub>	Turn-Off Delay Time		--	200	--	ns
t <sub>f</sub>	Fall Time		--	154	--	ns
E <sub>on</sub>	Turn-On Switching Loss		--	4.3	--	mJ
E <sub>off</sub>	Turn-Off Switching Loss		--	1.5	--	mJ
E <sub>ts</sub>	Total Switching Loss		--	5.8	--	mJ
Q <sub>g</sub>	Total Gate Charge	V <sub>CE</sub> = 600 V, I <sub>C</sub> = 25 A, V <sub>GE</sub> = 15 V	--	200	--	nC
Q <sub>ge</sub>	Gate-Emitter Charge		--	15	--	nC
Q <sub>gc</sub>	Gate-Collector Charge		--	100	--	nC

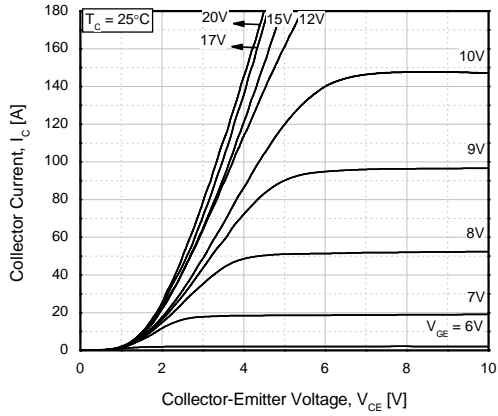
**Electrical Characteristics of DIODE**  $T_C = 25^\circ\text{C}$  unless otherwise noted

Symbol	Parameter	Test Conditions	Min.	Typ.	Max.	Unit	
$V_{FM}$	Diode Forward Voltage	$I_F = 25\text{ A}$	$T_C = 25^\circ\text{C}$	--	2.0	3.0	V
			$T_C = 125^\circ\text{C}$	--	2.1	--	
$t_{rr}$	Diode Reverse Recovery Time	$I_F = 25\text{ A}$ $di_F/dt = 200\text{ A}/\mu\text{s}$	$T_C = 25^\circ\text{C}$	--	235	350	ns
			$T_C = 125^\circ\text{C}$	--	300	--	
$I_{rr}$	Diode Peak Reverse Recovery Current		$T_C = 25^\circ\text{C}$	--	27	40	A
			$T_C = 125^\circ\text{C}$	--	31	--	
$Q_{rr}$	Diode Reverse Recovery Charge		$T_C = 25^\circ\text{C}$	--	3130	4700	nC
			$T_C = 125^\circ\text{C}$	--	4650	--	

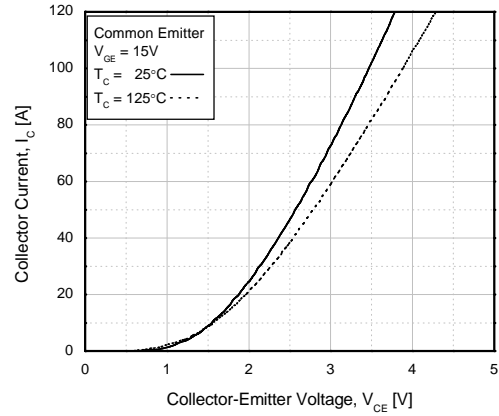


## Typical Performance Characteristics

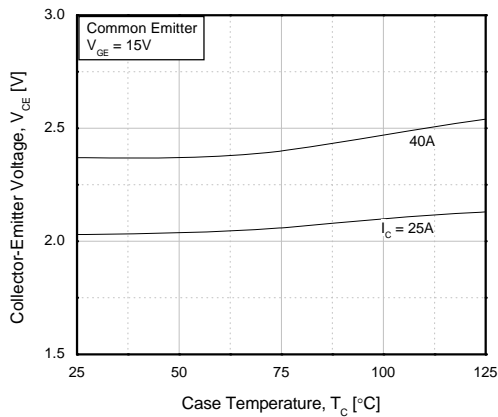
**Figure 1. Typical Output Characteristics**



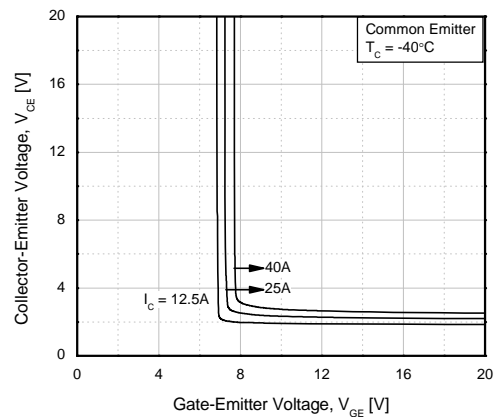
**Figure 2. Typical Saturation Voltage Characteristics**



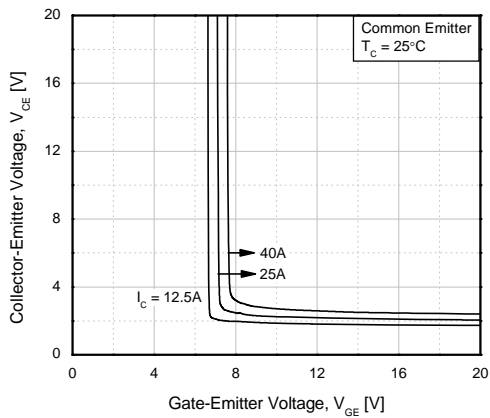
**Figure 3. Saturation Voltage vs. Case Temperature at Variant Current Level**



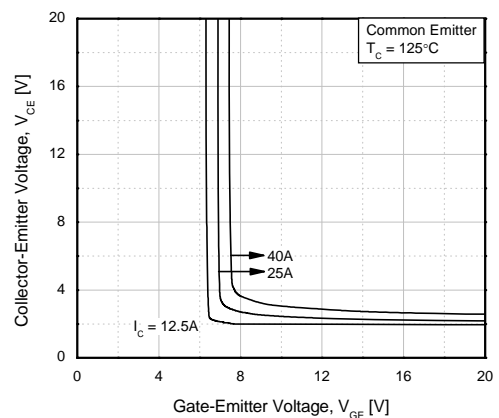
**Figure 4. Saturation Voltage vs. V\_GE**



**Figure 5. Saturation Voltage vs. V\_GE**

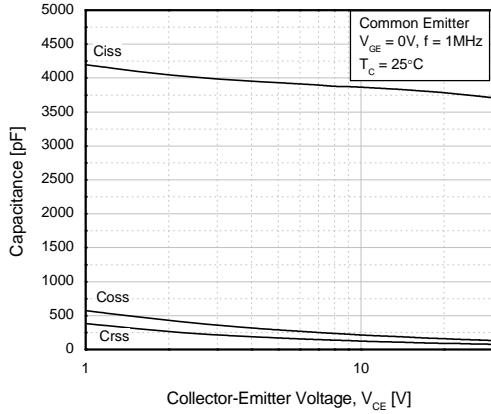


**Figure 6. Saturation Voltage vs. V\_GE**

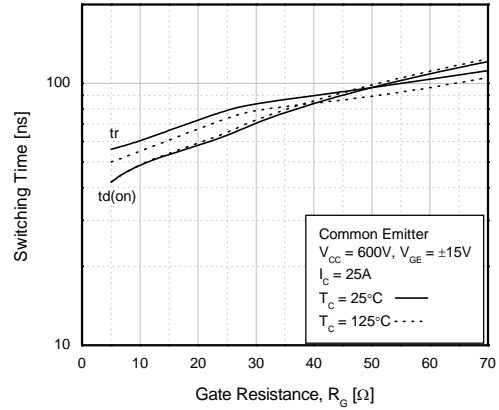


**Typical Performance Characteristics** (Continued)

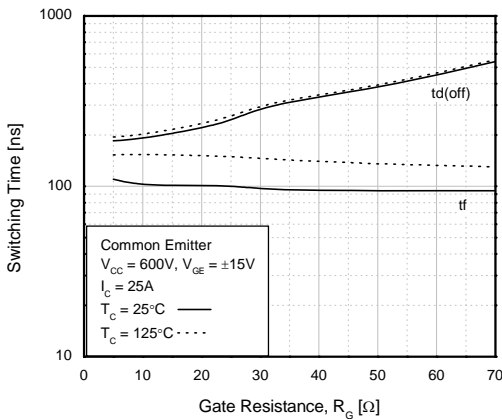
**Figure 7. Capacitance Characteristics**



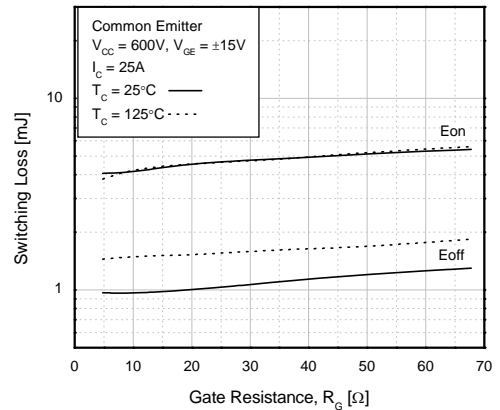
**Figure 8. Turn-On Characteristics vs. Gate Resistance**



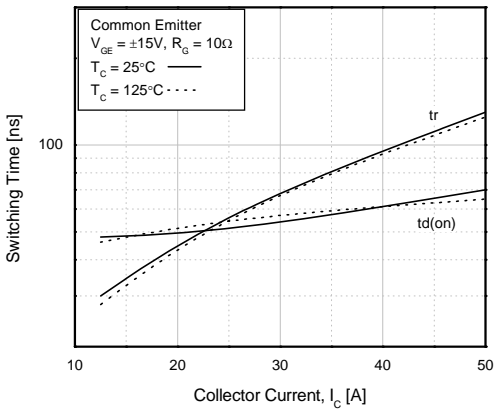
**Figure 9. Turn-Off Characteristics vs. Gate Resistance**



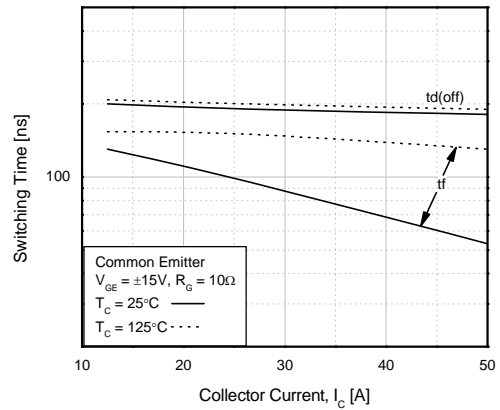
**Figure 10. Switching Loss vs. Gate Resistance**



**Figure 11. Turn-On Characteristics vs. Collector Current**

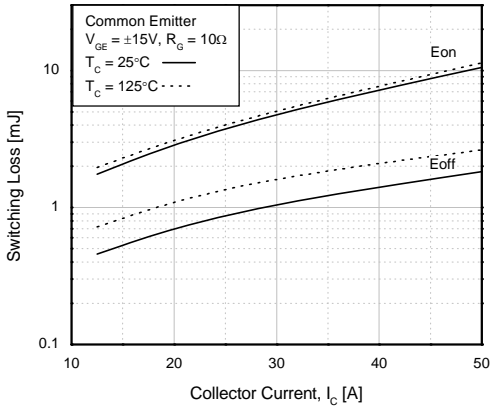


**Figure 12. Turn-Off Characteristics vs. Collector Current**

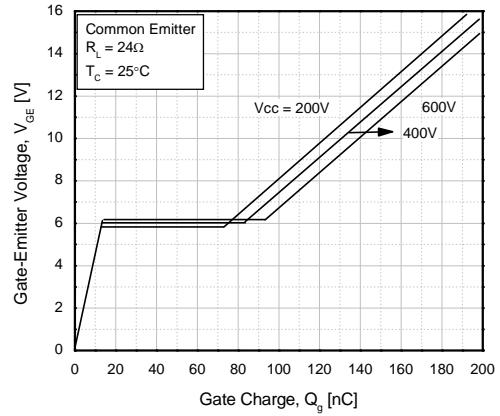


**Typical Performance Characteristics (Continued)**

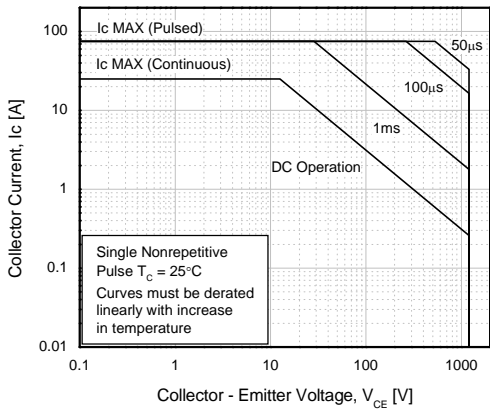
**Figure 13. Switching Loss vs. Collector Current**



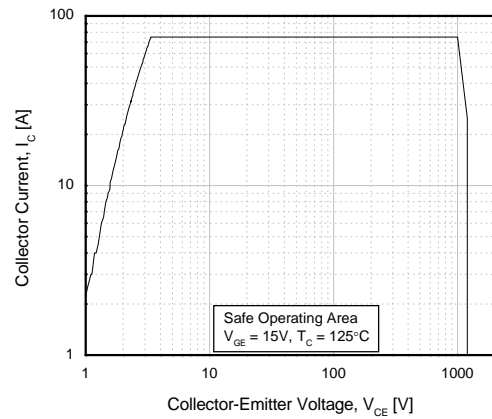
**Figure 14. Gate Charge Characteristics**



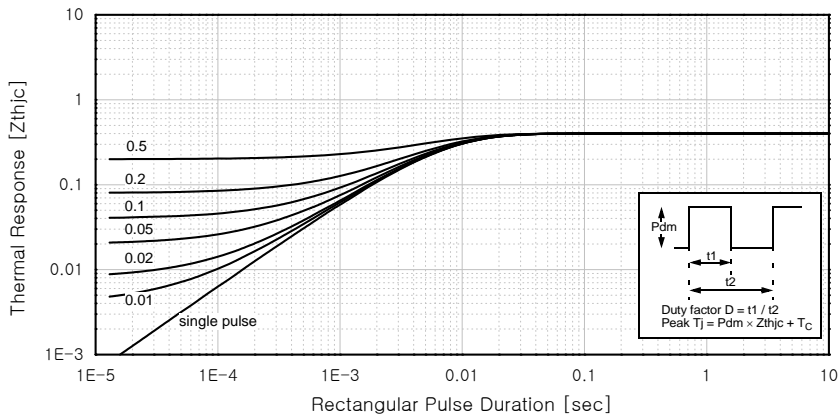
**Figure 15. SOA Characteristics**



**Figure 16. Turn-Off SOA**



**Figure 17. Transient Thermal Impedance of IGBT**



Typical Performance Characteristics (Continued)

Figure 18. Forward Characteristics

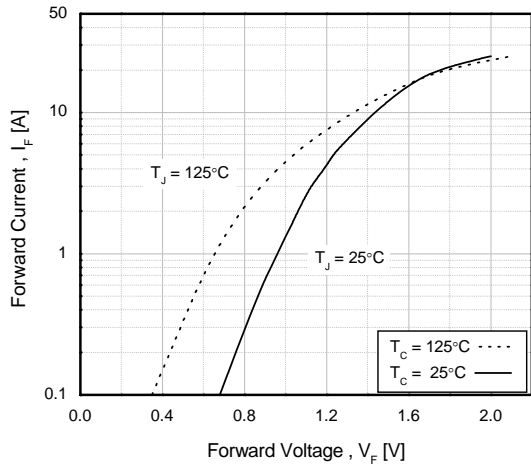


Figure 19. Reverse Recovery Current

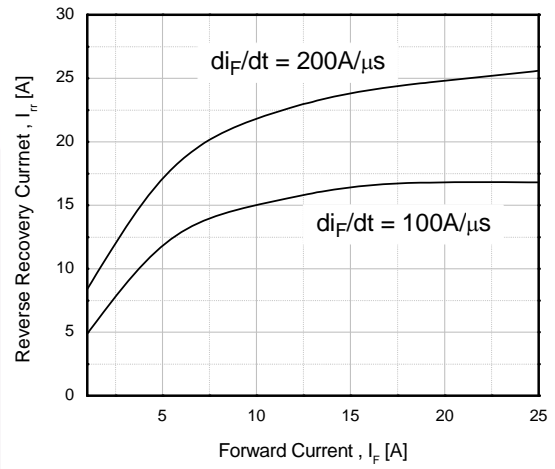


Figure 20. Stored Charge

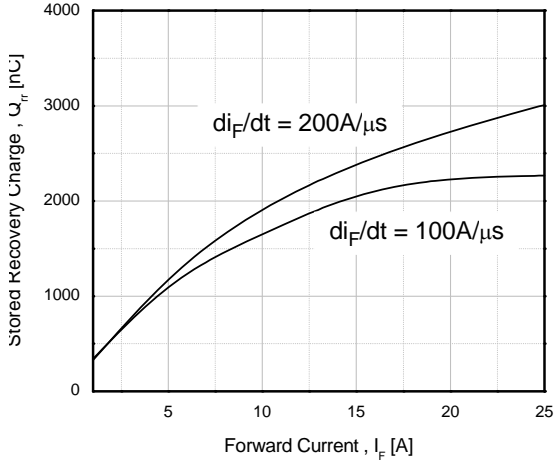
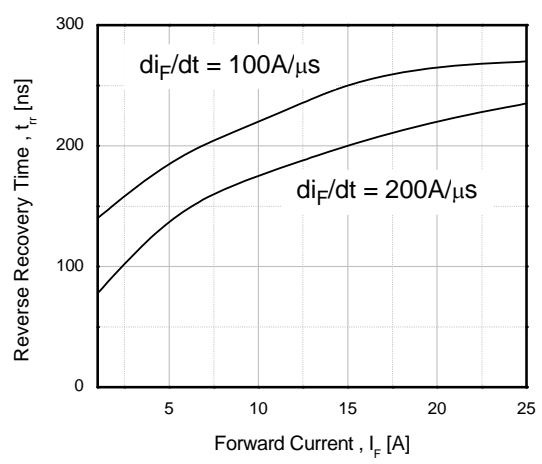
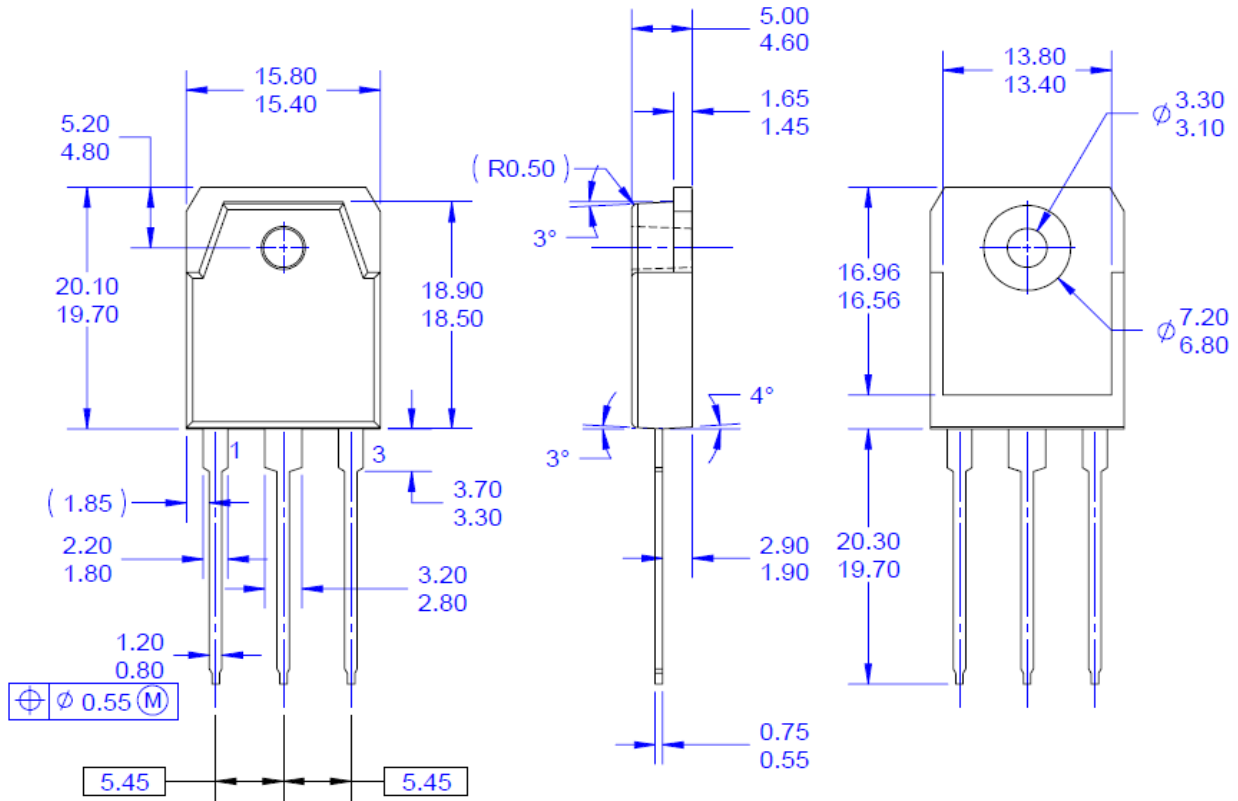


Figure 21. Reverse Recovery Time



## Mechanical Dimensions



NOTES: UNLESS OTHERWISE SPECIFIED

- A) THIS PACKAGE CONFORMS TO EIAJ SC-65 PACKAGING STANDARD.
- B) ALL DIMENSIONS ARE IN MILLIMETERS.
- C) DIMENSION AND TOLERANCING PER ASME14.5
- D) DIMENSIONS ARE EXCLUSIVE OF BURRS, MOLD FLASH, AND TIE BAR EXTRUSIONS.
- E) THIS PACKAGE IS INTENDED ONLY FOR T03PN.
- F) DRAWING FILE NAME: T03P03AREV4.

**Figure 22. TO-3P 3L - 3LD, T03, PLASTIC, EIAJ SC-65**

Package drawings are provided as a service to customers considering Fairchild components. Drawings may change in any manner without notice. Please note the revision and/or date on the drawing and contact a Fairchild Semiconductor representative to verify or obtain the most recent revision. Package specifications do not expand the terms of Fairchild's worldwide terms and conditions, specifically the warranty therein, which covers Fairchild products.

Always visit Fairchild Semiconductor's online packaging area for the most recent package drawings:

[http://www.fairchildsemi.com/package/packageDetails.html?id=PN\\_TT3P0-003](http://www.fairchildsemi.com/package/packageDetails.html?id=PN_TT3P0-003)





**TRADEMARKS**

The following includes registered and unregistered trademarks and service marks, owned by Fairchild Semiconductor and/or its global subsidiaries, and is not intended to be an exhaustive list of all such trademarks.

- |  |   |   |  |
|--|---|---|--|
| AccuPower™   | F-PFST™   | PowerTrench®  | Sync-Lock™   |
| AX-CAP®*   | FRFET®  | PowerXS™  |  SYSTEM®* |
| BitSiC™  | Global Power Resource <sup>SM</sup>             | Programmable Active Droop™  | TinyBoost®   |
| Build it Now™  | GreenBridge™                                    | QFET®   | TinyBuck™  |
| CorePLUS™  | Green FPS™                                      | QS™   | TinyCalc™  |
| CorePOWER™   | Green FPS™ e-Series™                            | Quiet Series™   | TinyLogic®   |
| CROSSVOLT™   | Gmax™   | RapidConfigure™   | TINYOPTO™  |
| CTL™   | GTO™  |   | TinyPower™   |
| Current Transfer Logic™  | IntelliMAX™                                     |  Saving our world, 1mW/W/kW at a time™ | TinyPWM™   |
| DEUXPEED®  | ISOPLANAR™                                      | SignalWise™   | TinyWire™  |
| Dual Cool™   | Marking Small Speakers Sound Louder and Better™ | SmartMax™   | TranSiC™   |
| EcoSPARK®  | MegaBuck™                                       | SMART START™  | TriFault Detect™   |
| EfficientMax™  | MICROCOUPLER™                                   | Solutions for Your Success™   | TRUECURRENT®*  |
| ESBC™  | MicroFET™                                       | SPM®  | µSerDes™   |
|  Fairchild® | MicroPak™                                       | STEALTH™  |  SerDes®  |
| Fairchild Semiconductor®   | MicroPak2™                                      | SuperFET®   | UHC®   |
| FACT Quiet Series™   | MillerDrive™                                    | SuperSOT™-3   | Ultra FRFET™   |
| FACT®  | MotionMax™                                      | SuperSOT™-6   | UniFET™  |
| FAST®  | mWSaver®  | SuperSOT™-8   | VCX™   |
| FastvCore™   | OptoHiT™  | SupreMOS®   | VisualMax™   |
| FETBench™  | OPTOLOGIC®                                      | SyncFET™  | VoltagePlus™   |
| FPS™   | OPTOPLANAR®                                     |   | XS™  |

\*Trademarks of System General Corporation, used under license by Fairchild Semiconductor.

**DISCLAIMER**

FAIRCHILD SEMICONDUCTOR RESERVES THE RIGHT TO MAKE CHANGES WITHOUT FURTHER NOTICE TO ANY PRODUCTS HEREIN TO IMPROVE RELIABILITY, FUNCTION, OR DESIGN. FAIRCHILD DOES NOT ASSUME ANY LIABILITY ARISING OUT OF THE APPLICATION OR USE OF ANY PRODUCT OR CIRCUIT DESCRIBED HEREIN; NEITHER DOES IT CONVEY ANY LICENSE UNDER ITS PATENT RIGHTS, NOR THE RIGHTS OF OTHERS. THESE SPECIFICATIONS DO NOT EXPAND THE TERMS OF FAIRCHILD'S WORLDWIDE TERMS AND CONDITIONS, SPECIFICALLY THE WARRANTY THEREIN, WHICH COVERS THESE PRODUCTS.

**LIFE SUPPORT POLICY**

FAIRCHILD'S PRODUCTS ARE NOT AUTHORIZED FOR USE AS CRITICAL COMPONENTS IN LIFE SUPPORT DEVICES OR SYSTEMS WITHOUT THE EXPRESS WRITTEN APPROVAL OF FAIRCHILD SEMICONDUCTOR CORPORATION.

As used here in:

1. Life support devices or systems are devices or systems which, (a) are intended for surgical implant into the body or (b) support or sustain life, and (c) whose failure to perform when properly used in accordance with instructions for use provided in the labeling, can be reasonably expected to result in a significant injury of the user.
2. A critical component in any component of a life support, device, or system whose failure to perform can be reasonably expected to cause the failure of the life support device or system, or to affect its safety or effectiveness.

**ANTI-COUNTERFEITING POLICY**

Fairchild Semiconductor Corporation's Anti-Counterfeiting Policy. Fairchild's Anti-Counterfeiting Policy is also stated on our external website, [www.Fairchildsemi.com](http://www.Fairchildsemi.com), under Sales Support. Counterfeiting of semiconductor parts is a growing problem in the industry. All manufactures of semiconductor products are experiencing counterfeiting of their parts. Customers who inadvertently purchase counterfeit parts experience many problems such as loss of brand reputation, substandard performance, failed application, and increased cost of production and manufacturing delays. Fairchild is taking strong measures to protect ourselves and our customers from the proliferation of counterfeit parts. Fairchild strongly encourages customers to purchase Fairchild parts either directly from Fairchild or from Authorized Fairchild Distributors who are listed by country on our web page cited above. Products customers buy either from Fairchild directly or from Authorized Fairchild Distributors are genuine parts, have full traceability, meet Fairchild's quality standards for handling and storage and provide access to Fairchild's full range of up-to-date technical and product information. Fairchild and our Authorized Distributors will stand behind all warranties and will appropriately address and warranty issues that may arise. Fairchild will not provide any warranty coverage or other assistance for parts bought from Unauthorized Sources. Fairchild is committed to combat this global problem and encourage our customers to do their part in stopping this practice by buying direct or from authorized distributors.

**PRODUCT STATUS DEFINITIONS**

**Definition of Terms**

Datasheet Identification	Product Status	Definition
Advance Information	Formative / In Design	Datasheet contains the design specifications for product development. Specifications may change in any manner without notice.
Preliminary	First Production	Datasheet contains preliminary data; supplementary data will be published at a later date. Fairchild Semiconductor reserves the right to make changes at any time without notice to improve design.
No Identification Needed	Full Production	Datasheet contains final specifications. Fairchild Semiconductor reserves the right to make changes at any time without notice to improve the design.
Obsolete	Not In Production	Datasheet contains specifications on a product that is discontinued by Fairchild Semiconductor. The datasheet is for reference information only.

Rev. I66

# Mouser Electronics

Authorized Distributor

Click to View Pricing, Inventory, Delivery & Lifecycle Information:

[Fairchild Semiconductor:](#)

[FGA25N120ANTDTU](#)