

## LOW DROPOUT VOLTAGE REGULATOR

### ■ GENERAL DESCRIPTION

The NJM2845 is low dropout voltage regulator. Advanced Bipolar technology achieves low noise, high ripple rejection and low quiescent current.

NJM2845 is 3 terminal type and NJM2846 is ON/OFF control built in type. These product can be selected according to the applications.

### ■ PACKAGE OUTLINE

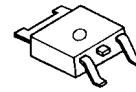

NJM2845DL1

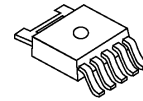

NJM2846DL3

### ■ FEATURES

- High Ripple Rejection           75dB typ. (f=1kHz,3V Version)
- Output Noise Voltage           V<sub>no</sub>=45μV<sub>rms</sub> typ. (V<sub>o</sub>=3V Version)
- Output capacitor with 2.2μF ceramic capacitor (V<sub>o</sub>≥2.6V)
- Output Current                   I<sub>o</sub>(max.)=800mA
- High Precision Output           V<sub>o</sub> ±1.0%
- Low Dropout Voltage           0.18V typ. (I<sub>o</sub>=500mA)
- ON/OFF Control                 (NJM2846)
- Internal Short Circuit Current Limit
- Internal Thermal Overload Protection
- Bipolar Technology
- Package Outline                 TO-252-3 (NJM2845DL1), TO-252-5 (NJM2846DL3)

### ■ PIN CONFIGURATION

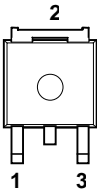

NJM2845DL1

- 1.V<sub>IN</sub>
- 2.GND
- 3.V<sub>OUT</sub>

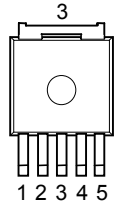

NJM2846DL3

- 1.CONTROL
- 2.V<sub>IN</sub>
- 3.GND
- 4.V<sub>o</sub>
- 5.NC

### ■ EQUIVALENT CIRCUIT

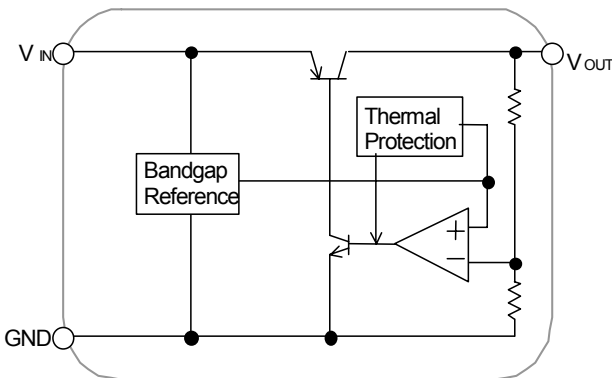

NJM2845DL1

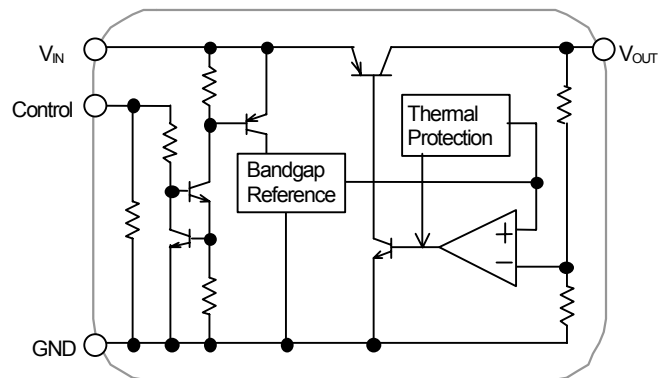

NJM2846DL3

# NJM2845/46

## ■ OUTPUT VOLTAGE RANK LIST

Device Name	V <sub>OUT</sub>
NJM284*DL*-18	1.8V
NJM284*DL*-23	2.3V
NJM284*DL*-25	2.5V
NJM284*DL*-03	3.0V
NJM284*DL*-33	3.3V
NJM284*DL*-05	5.0V

## ■ ABSOLUTE MAXIMUM RATINGS (Ta=25°C)

PARAMETER	SYMBOL	RATINGS	UNIT
Input Voltage	V <sub>IN</sub>	+14	V
Control Voltage	V <sub>CONT</sub>	+14(*1)	V
Power Dissipation	P <sub>D</sub>	10(Tc≤25°C) 1.0(Ta≤25°C)	W
Operating Temperature	Topr	-40 ~ +85	°C
Storage Temperature	Tstg	-40 ~ +150	°C

(\*1): When input voltage is less than +14V, the absolute maximum control voltage is equal to the input voltage.

## ■ Operating voltage

$$V_{IN}=+2.5V(\text{In case of } V_o < 2.3V) \sim +(V_o+10V)$$

## ■ NJM2845

### ■ ELECTRICAL CHARACTERISTICS (V<sub>IN</sub>=V<sub>o</sub>+1V, C<sub>IN</sub>=0.33μF, C<sub>o</sub>=2.2μF(V<sub>o</sub>≤2.6V: C<sub>o</sub>=4.7μF), Ta=25°C)

PARAMETER	SYMBOL	TEST CONDITION	MIN.	TYP.	MAX.	UNIT
Output Voltage	V <sub>o</sub>	I <sub>o</sub> =30mA	-1.0%	-	+1.0%	V
Quiescent Current	I <sub>Q</sub>	I <sub>o</sub> =0mA	-	400	600	μA
Output Current	I <sub>o</sub>	V <sub>o</sub> - 0.3V	800	1050	-	mA
Line Regulation	ΔV <sub>o</sub> /ΔV <sub>IN</sub>	V <sub>IN</sub> =V <sub>o</sub> +1V ~ V <sub>o</sub> +6V, I <sub>o</sub> =30mA	-	-	0.10	%/V
Load Regulation	ΔV <sub>o</sub> /ΔI <sub>o</sub>	I <sub>o</sub> =0 ~ 800mA	-	-	0.004	%/mA
Dropout Voltage(*2)	ΔV <sub>I-O</sub>	I <sub>o</sub> =500mA	-	0.18	0.28	V
Ripple Rejection	RR	e <sub>in</sub> =200mVrms, f=1kHz, I <sub>o</sub> =10mA, V <sub>o</sub> =3V Version	-	75	-	dB
Average Temperature Coefficient of Output Voltage	ΔV <sub>o</sub> /ΔTa	Ta=0 ~ 85°C, I <sub>o</sub> =10mA	-	± 50	-	ppm/°C
Output Noise Voltage	V <sub>NO</sub>	f=10Hz ~ 80kHz, I <sub>o</sub> =10mA, V <sub>o</sub> =3V Version	-	45	-	μVrms

(\*2): The output voltage excludes under 2.3V.

The above specification is a common specification for all output voltages.

Therefore, it may be different from the individual specification for a specific output voltage.

## POWER DISSIPATION vs. AMBIENT TEMPERATURE

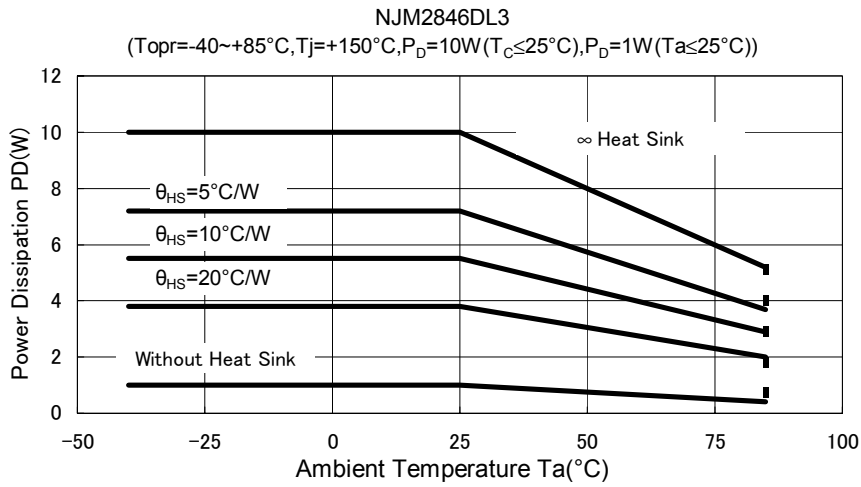

## TEST CIRCUIT

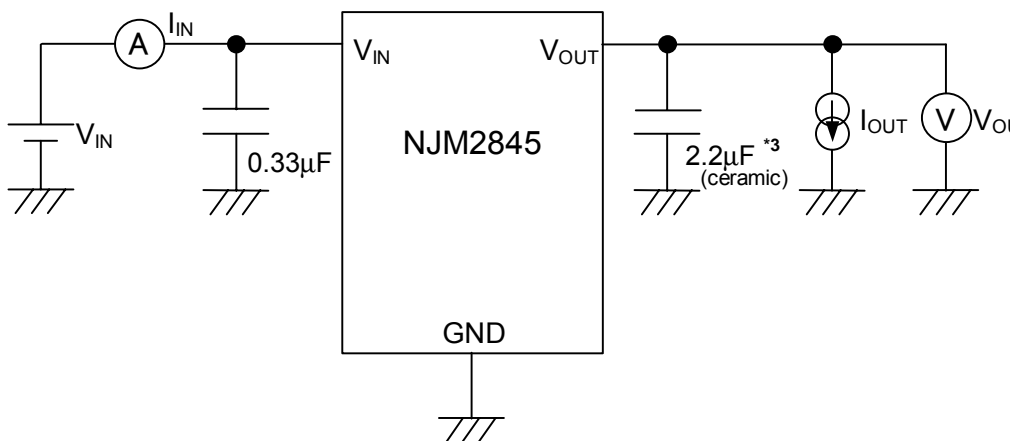

\*3  $V_o \leq 2.6\text{V}$  version:  $C_o = 4.7\mu\text{F}$  (ceramic)

## TYPICAL APPLICATION

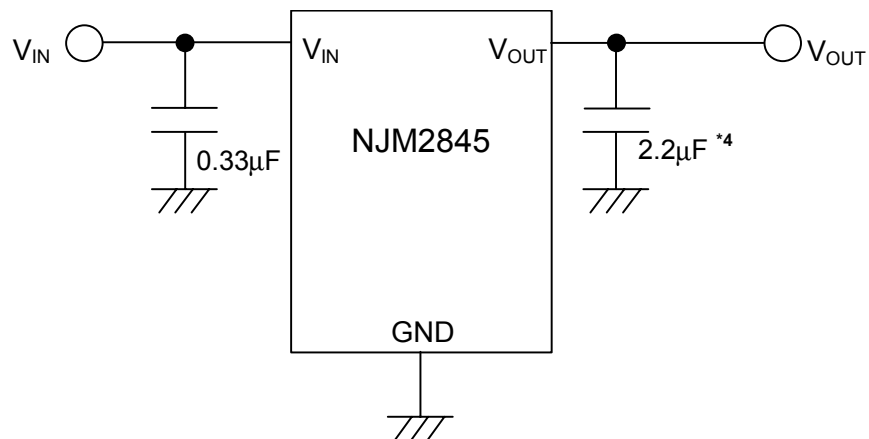

\*4  $V_o \leq 2.6\text{V}$  version:  $C_o = 4.7\mu\text{F}$

# NJM2845/46

## ■ NJM2846

### ■ ELECTRICAL CHARACTERISTICS ( $V_{IN}=V_o+1V$ , $C_{IN}=0.33\mu F$ , $C_o=2.2\mu F$ ( $V_o\leq 2.6V$ : $C_o=4.7\mu F$ ), $T_a=25^\circ C$ )

PARAMETER	SYMBOL	TEST CONDITION	MIN.	TYP.	MAX.	UNIT
Output Voltage	$V_o$	$I_o=30mA$	-1.0%	-	+1.0%	V
Quiescent Current	$I_Q$	$I_o=0mA$	-	400	600	$\mu A$
Quiescent Current at Control OFF	$I_{Q(OFF)}$	$V_{CONT}=0V$	-	-	100	nA
Line Regulation	$I_o$	$V_o - 0.3V$	800	1050	-	mA
Line Regulation	$\Delta V_o/\Delta V_{IN}$	$V_{IN}=V_o+1V \sim V_o+6V$ , $I_o=30mA$	-	-	0.10	%/V
Load Regulation	$\Delta V_o/\Delta I_o$	$I_o=0 \sim 800mA$	-	-	0.004	%/mA
Dropout Voltage(*5)	$\Delta V_{I-O}$	$I_o=500mA$	-	0.18	0.28	V
Ripple Rejection	RR	$e_{in}=200mV_{rms}$ , $f=1kHz$ , $I_o=10mA$ , $V_o=3V$ Version	-	75	-	dB
Average Temperature Coefficient of Output Voltage	$\Delta V_o/\Delta T_a$	$T_a=0 \sim 85^\circ C$ , $I_o=10mA$	-	$\pm 50$	-	ppm/ $^\circ C$
Output Noise Voltage	$V_{NO}$	$f=10Hz \sim 80kHz$ , $I_o=10mA$ , $V_o=3V$ Version	-	45	-	$\mu V_{rms}$
Control Current	$I_{CONT}$	$V_{CONT}=1.6V$ , $I_o=0mA$	-	3	12	$\mu A$
Control Voltage for ON-state	$V_{CONT(ON)}$		1.6	-	-	V
Control Voltage for OFF-state	$V_{CONT(OFF)}$		-	-	0.6	V

(\*5): The output voltage excludes under 2.3V.

The above specification is a common specification for all output voltages.

Therefore, it may be different from the individual specification for a specific output voltage.

## ■ POWER DISSIPATION vs. AMBIENT TEMPERATURE

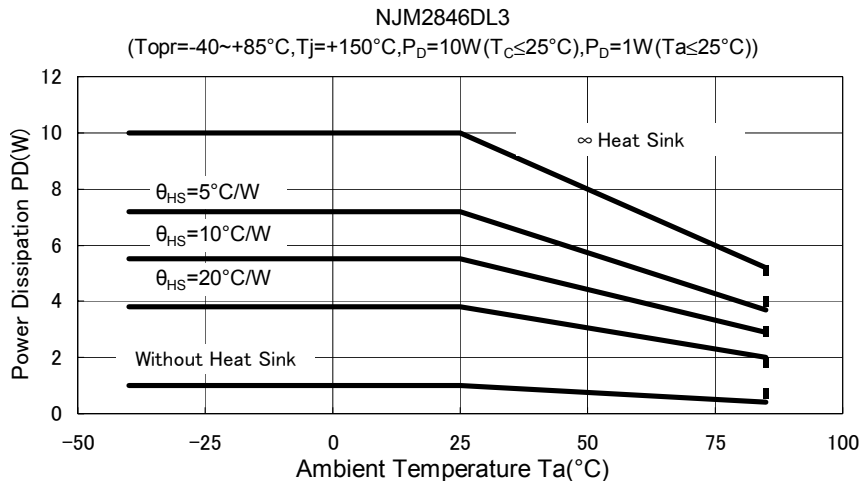

## ■ TEST CIRCUIT

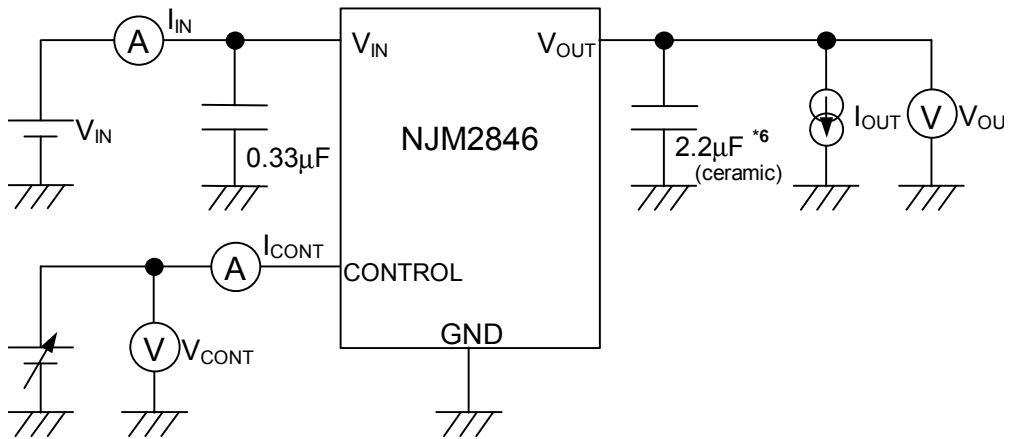

\*6  $V_o \leq 2.6V$  version:  $C_o = 4.7\mu F$  (ceramic)

# NJM2845/46

## ■ TYPICAL APPLICATION

① In the case where ON/OFF Control is not required:

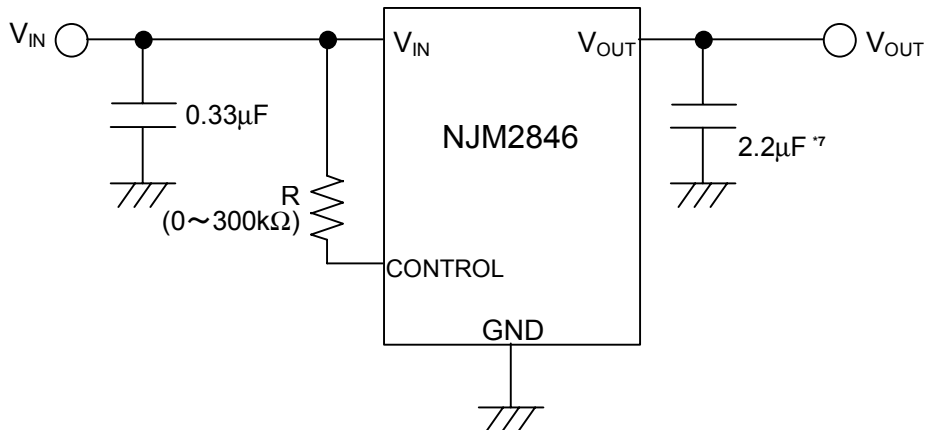

\*7  $V_o \leq 2.6V$  version:  $C_o = 4.7\mu F$

Connect control terminal to  $V_{IN}$  terminal

The quiescent current can be reduced by using a resistance "R". Instead, it increases the minimum operating voltage. For further information, please refer to Figure "Output Voltage vs. Control Voltage".

② In use of ON/OFF CONTROL:

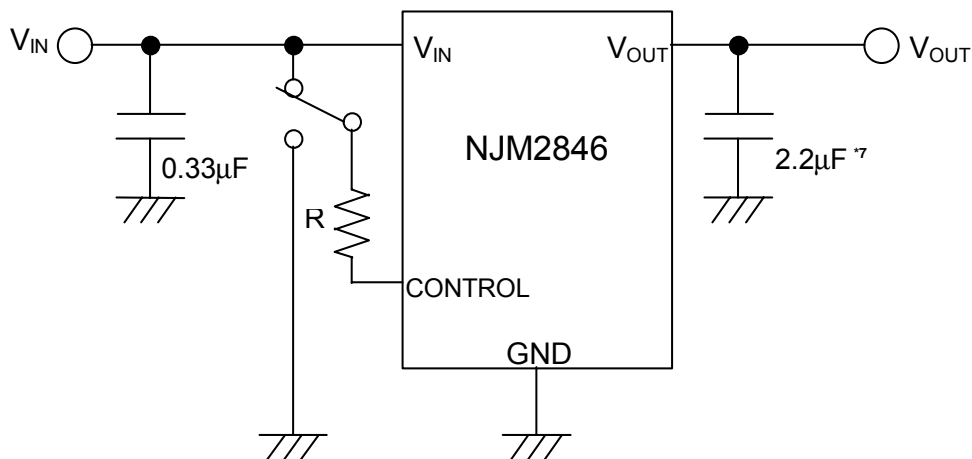

\*7  $V_o \leq 2.6V$  version:  $C_o = 4.7\mu F$

State of control terminal:

- "H" → output is enabled.
- "L" or "open" → output is disabled.

## ■ TYPICAL CHARACTERISTICS (NJM2845)

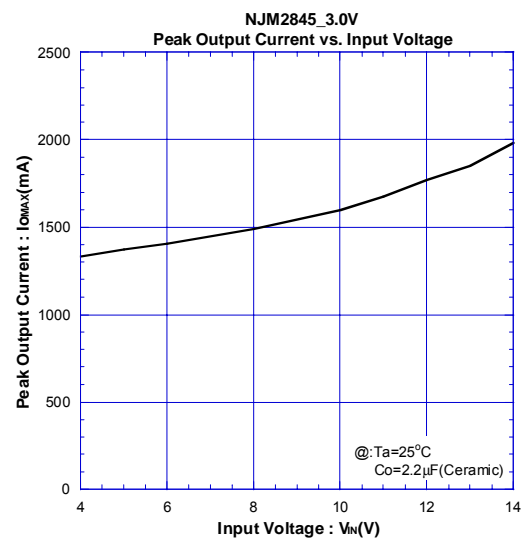
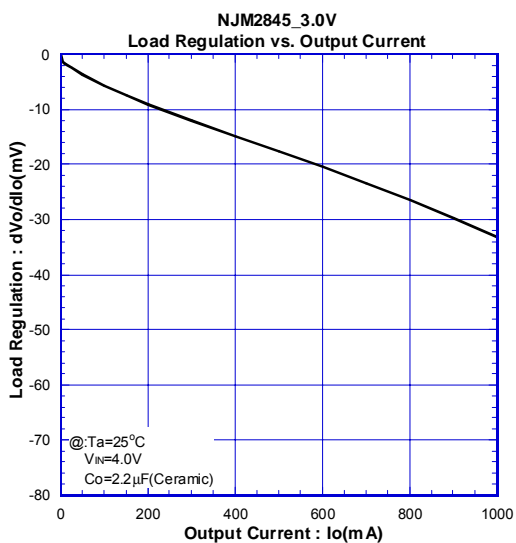
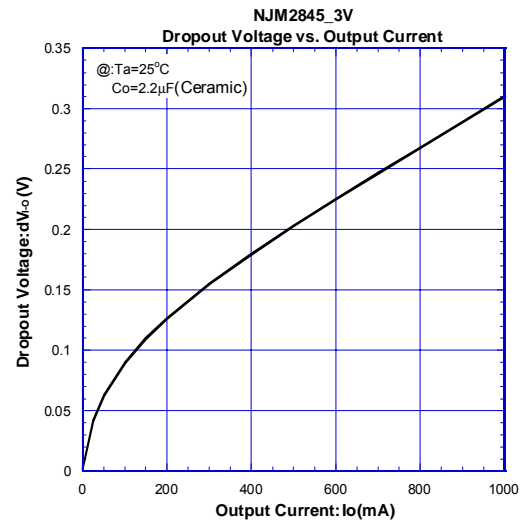
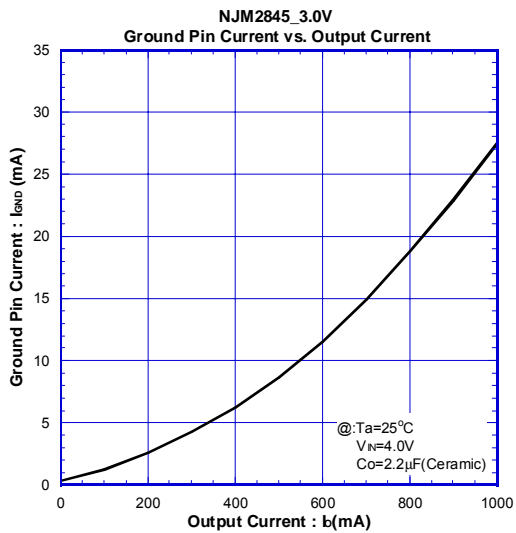
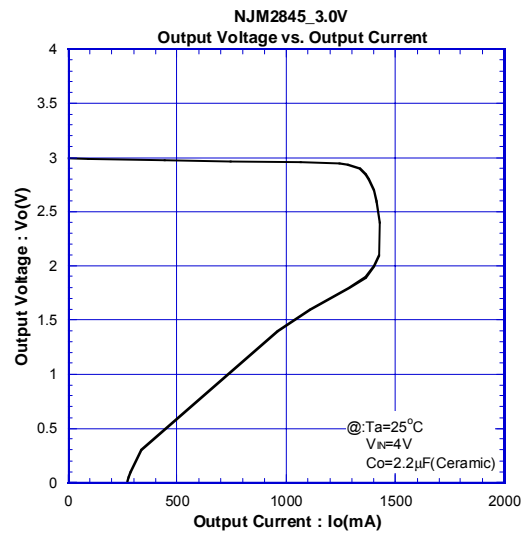
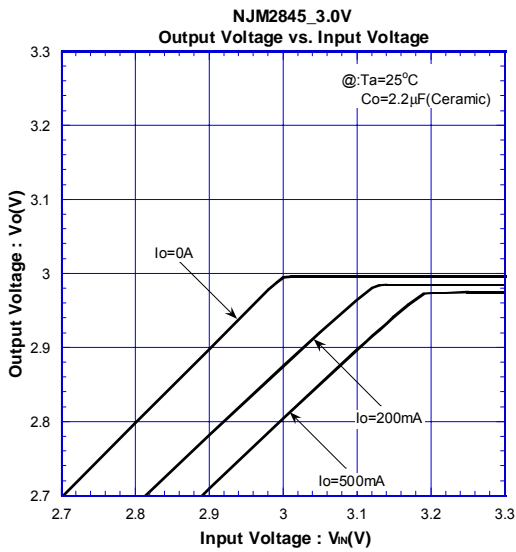

# NJM2845/46

## ■ TYPICAL CHARACTERISTICS (NJM2845)

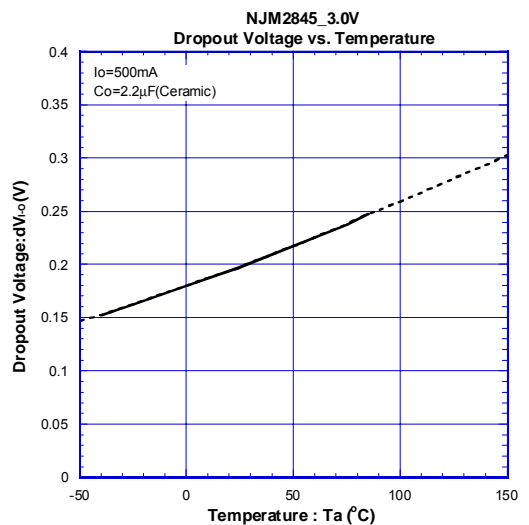
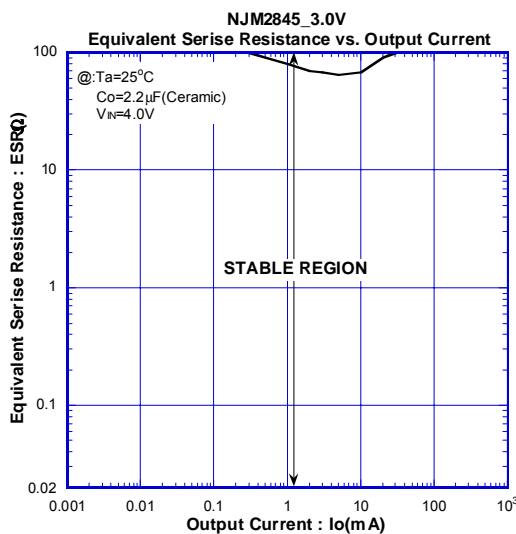
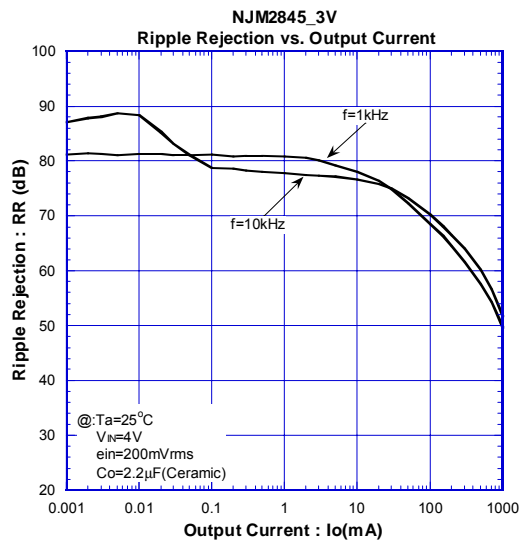
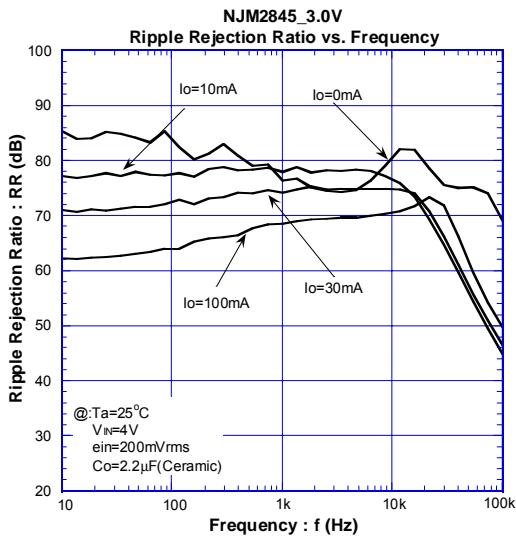
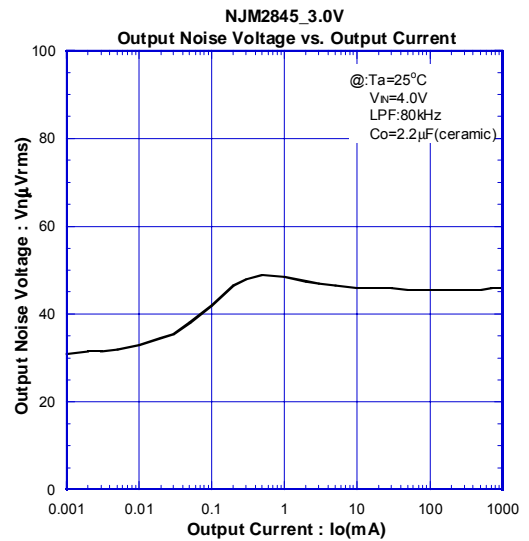
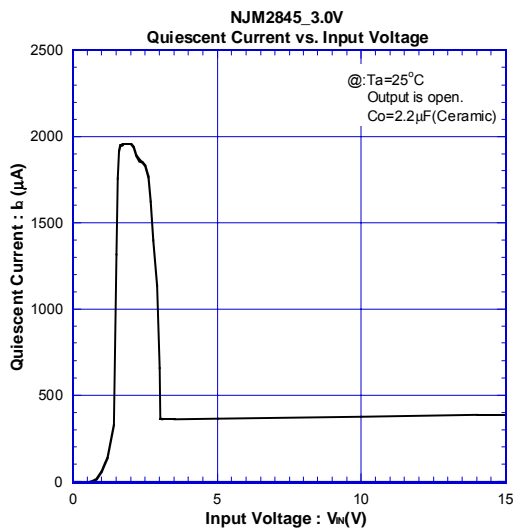



## ■ TYPICAL CHARACTERISTICS (NJM2845)

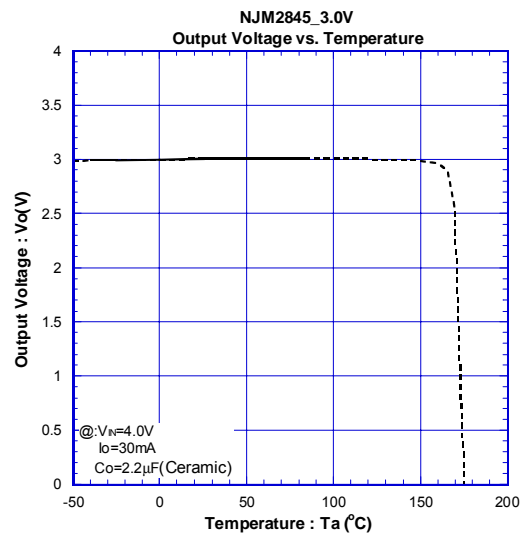
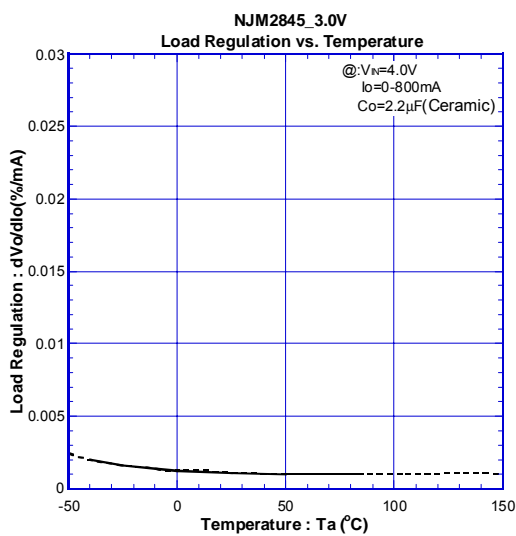
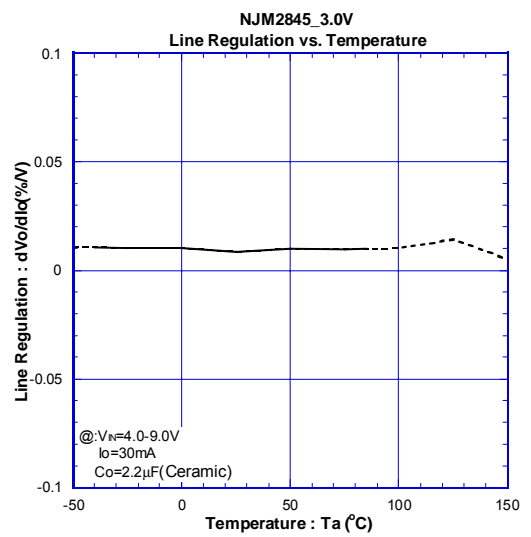
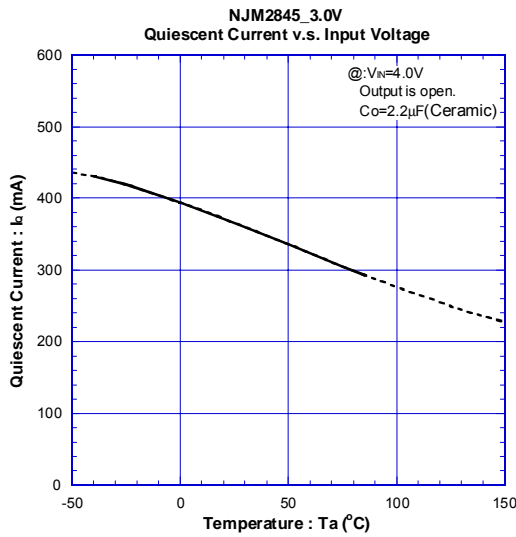
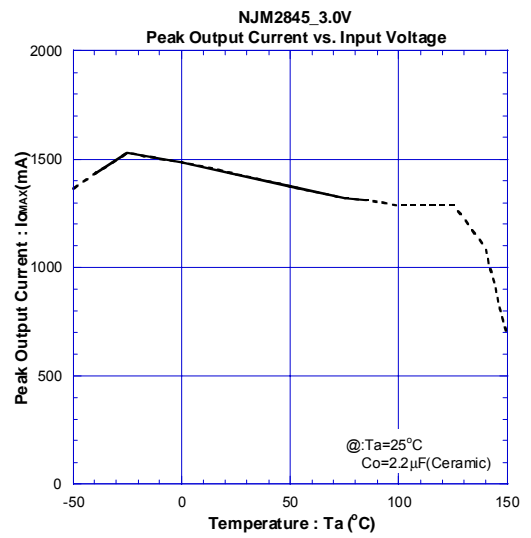
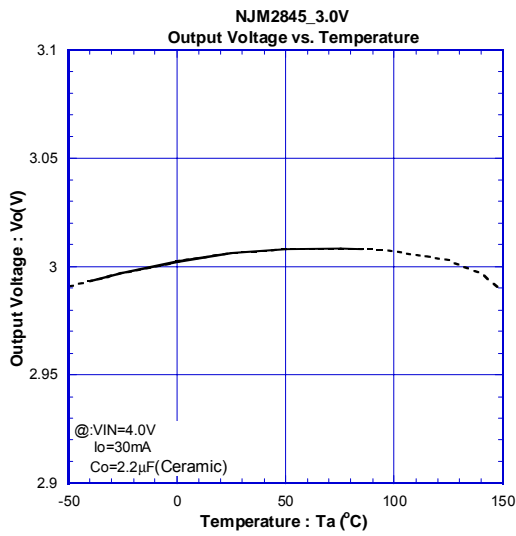

# NJM2845/46

## TYPICAL CHARACTERISTICS (NJM2845)

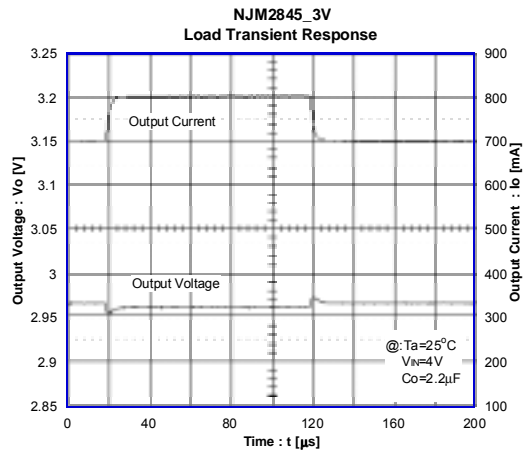
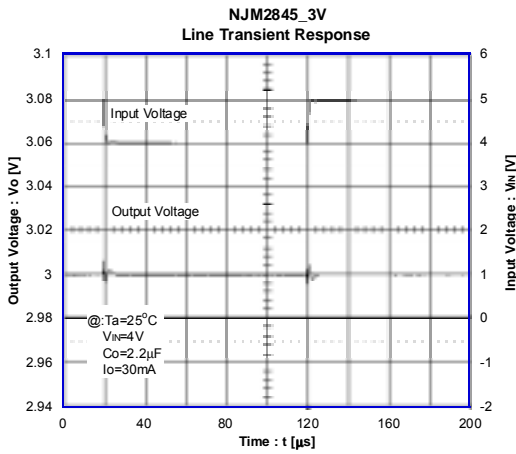
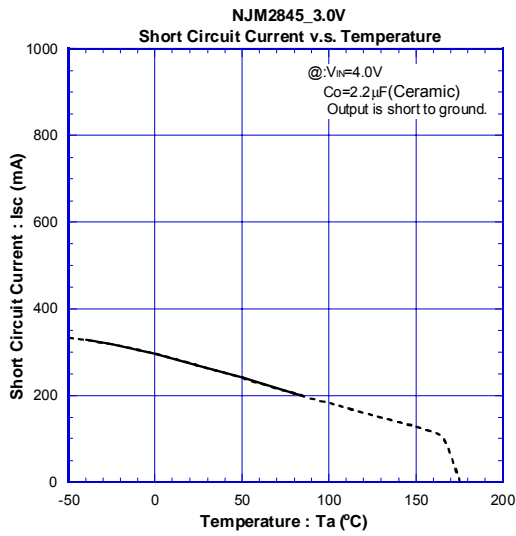

## ■ TYPICAL CHARACTERISTICS (NJM2846)

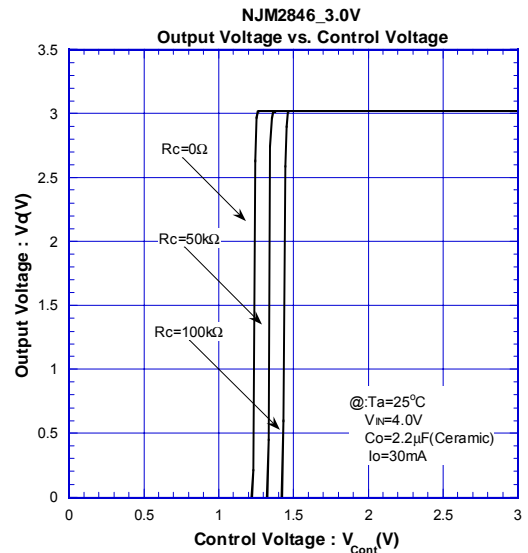
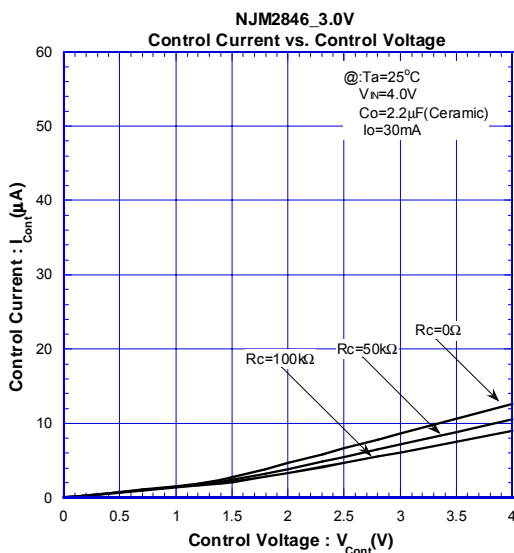
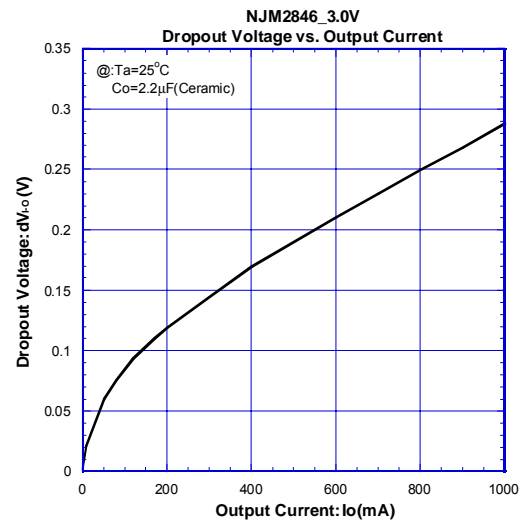
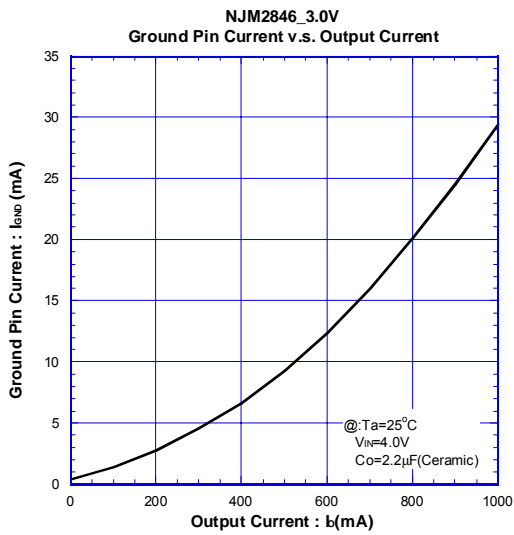
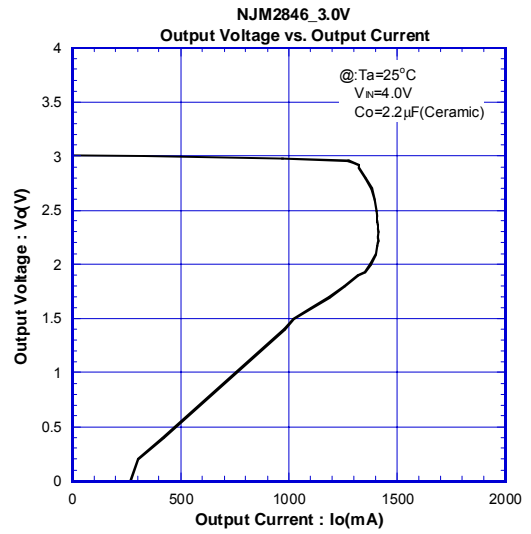
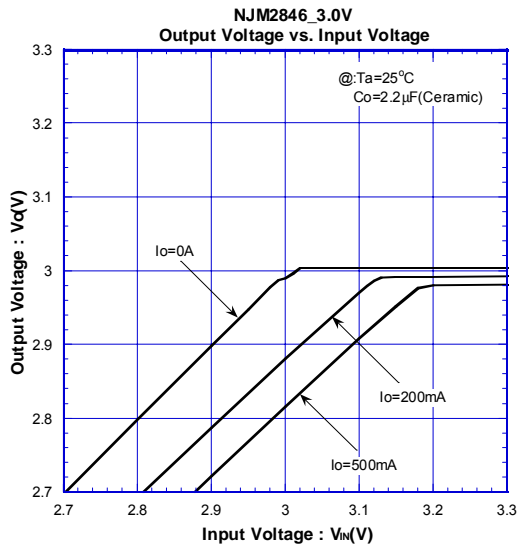

# NJM2845/46

## ■ TYPICAL CHARACTERISTICS (NJM2846)

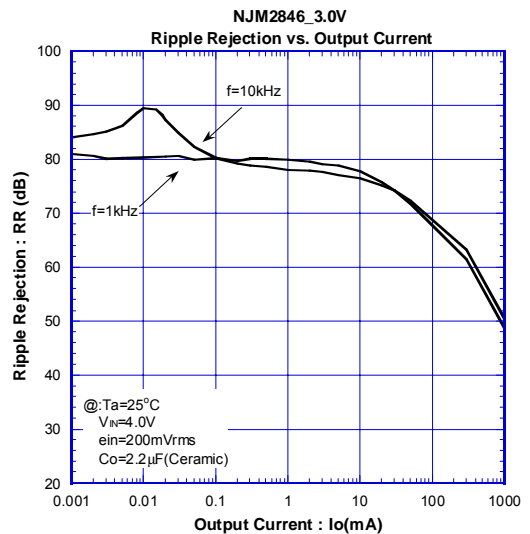
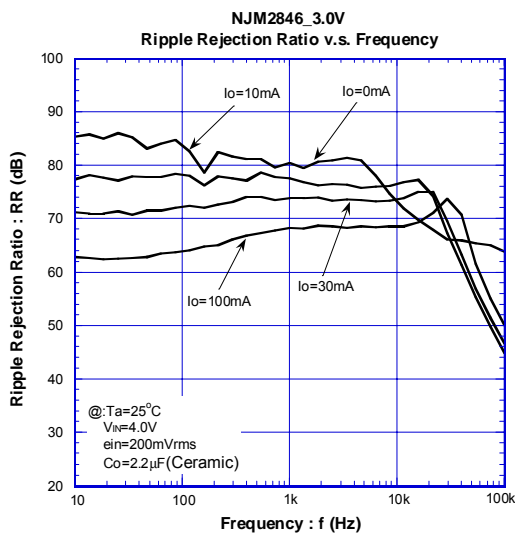
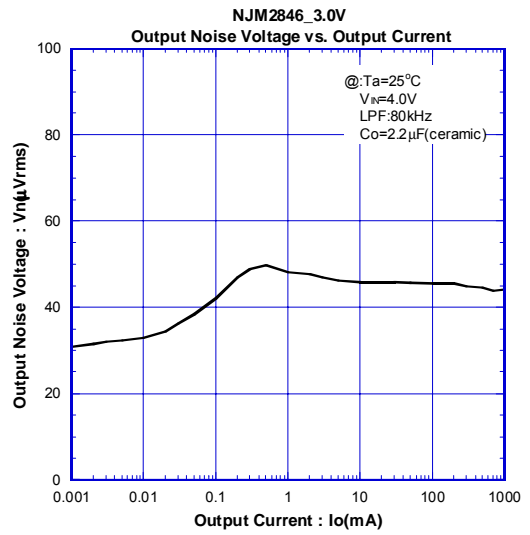
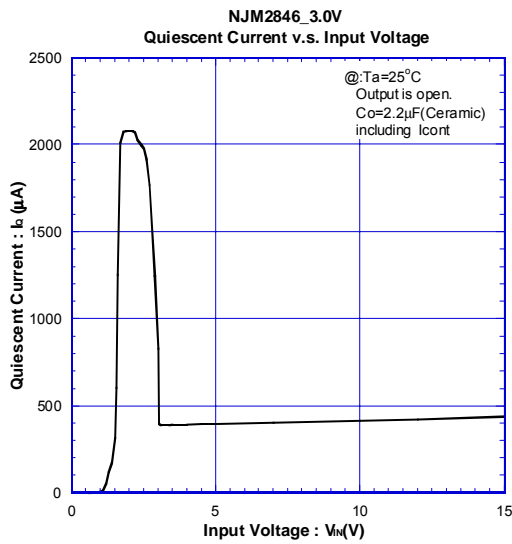
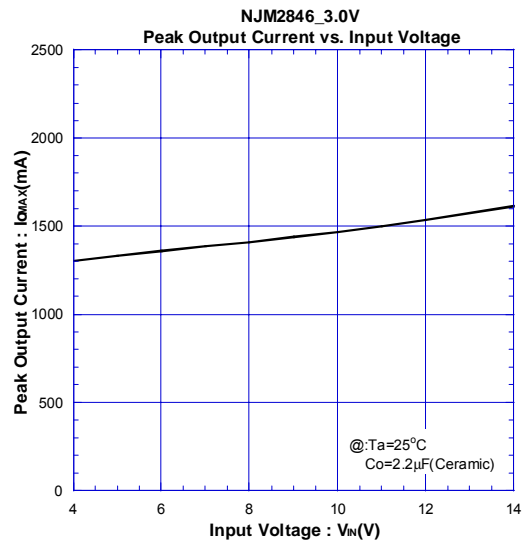
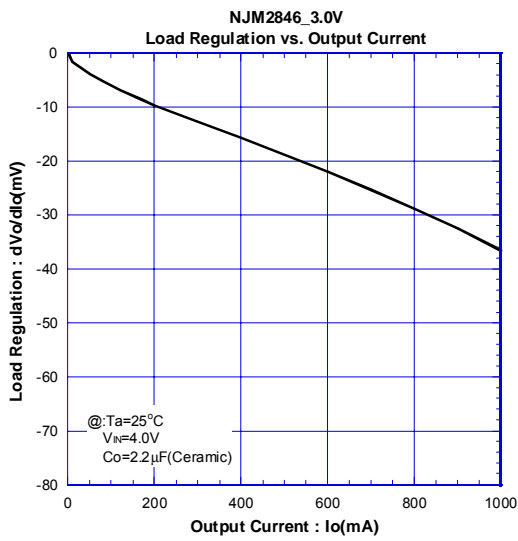

## ■ TYPICAL CHARACTERISTICS (NJM2846)

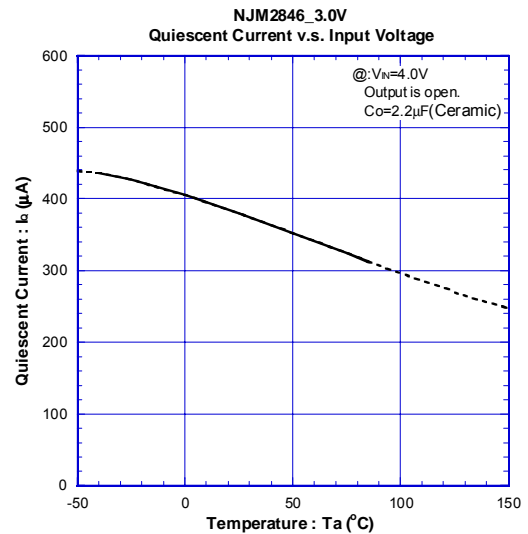
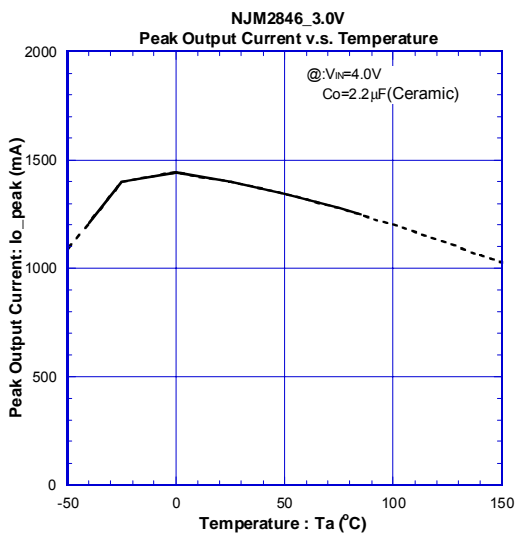
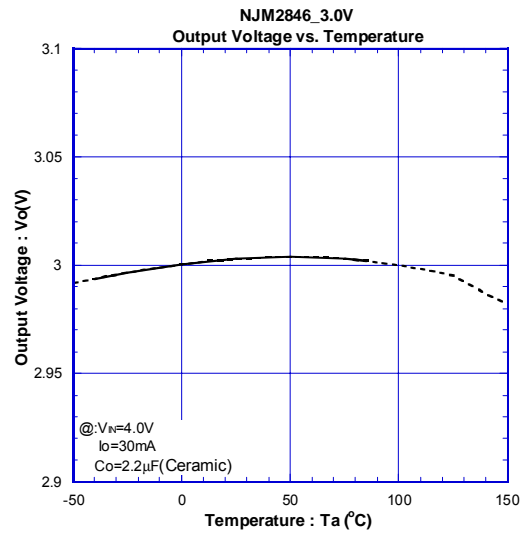
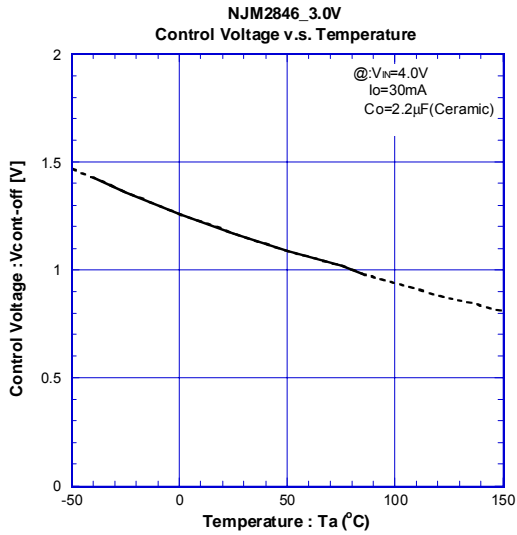
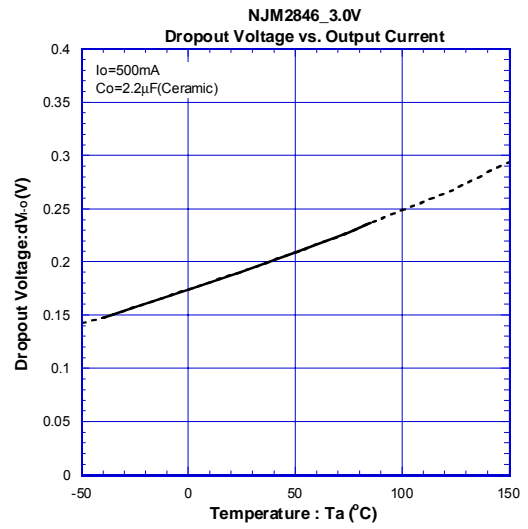
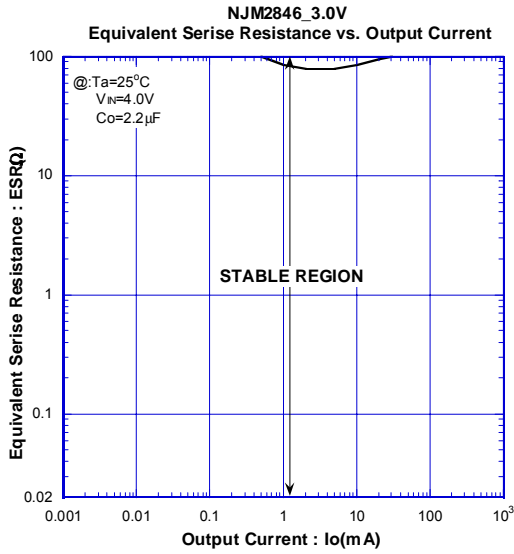

# NJM2845/46

## ■ TYPICAL CHARACTERISTICS (NJM2846)

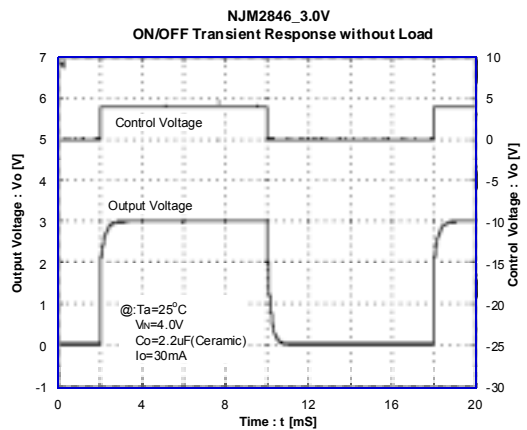
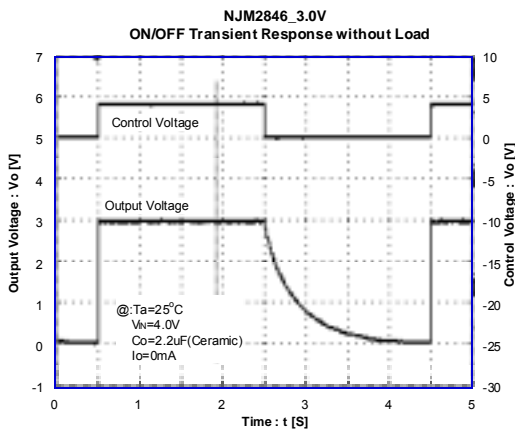
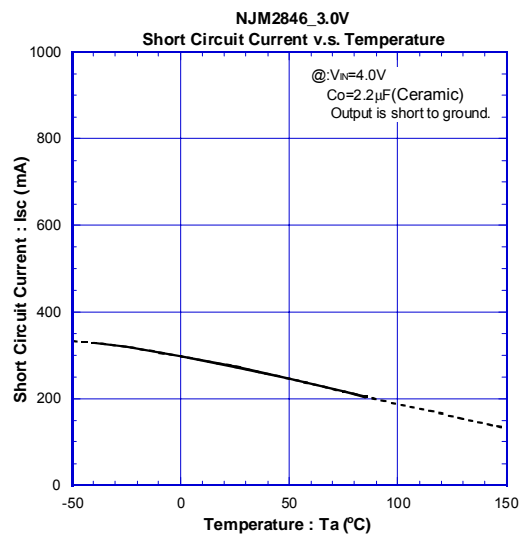
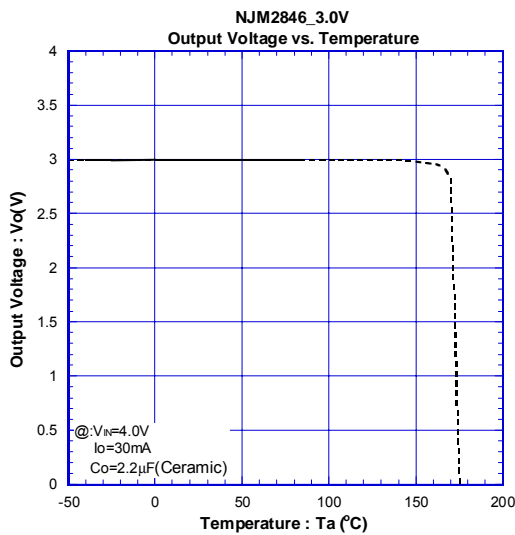
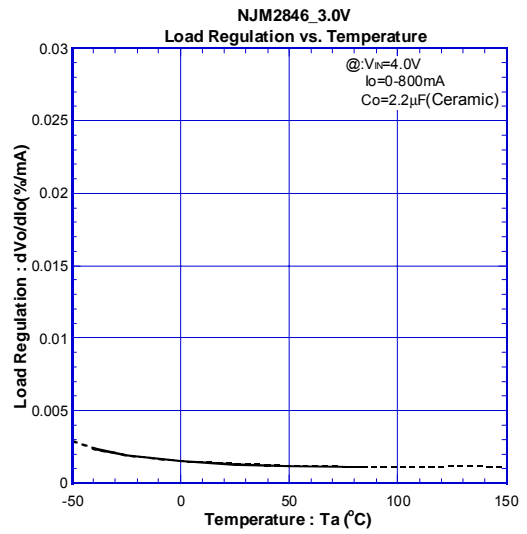
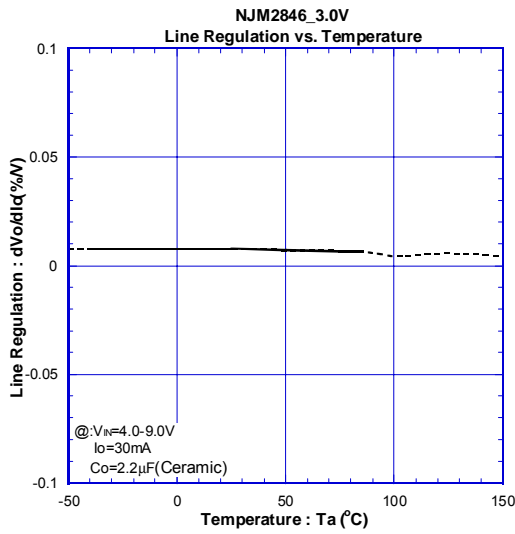

## ■ TYPICAL CHARACTERISTICS (NJM2846)

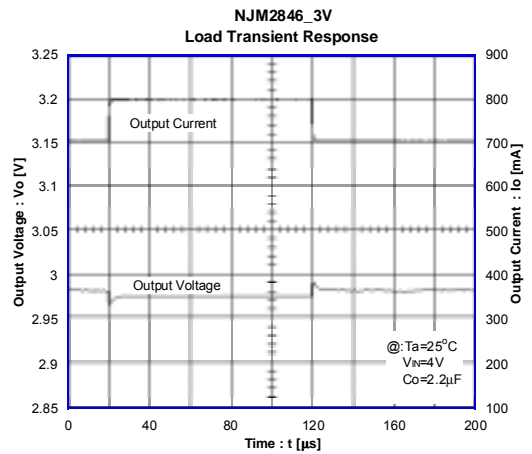
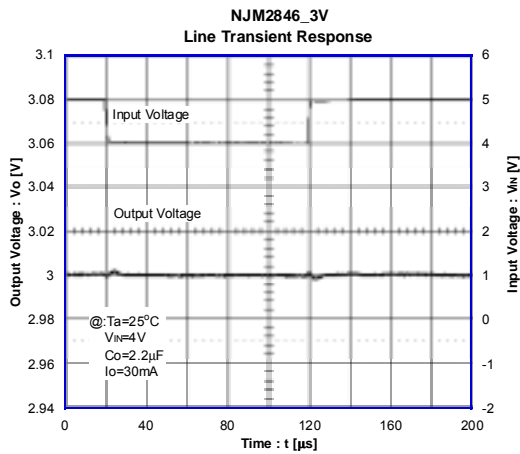

**[CAUTION]**

The specifications on this databook are only given for information, without any guarantee as regards either mistakes or omissions. The application circuits in this databook are described only to show representative usages of the product and not intended for the guarantee or permission of any right including the industrial rights.