

HM-R series FSK receiver module

GENERAL

HM-R series receiver module is specially designed by Hope Microelectronics Co., Ltd. For replacing those applications that used ASK technology module already. It used together with HM-T/HM-TP series FSK transmission module. Due to the benefits form FSK technology, the module is robust to interference, and longer working range can be achieved.

FEATURES

1. Highly integrated, small size
2. High sensitivity, low power consumption
3. FSK technology, suitable for replacing ASK modules
4. Less interference, longer working range
5. Can be used to replace ASK module pair W/O software modification
6. No manual tuning required during production

HM-R receiver module

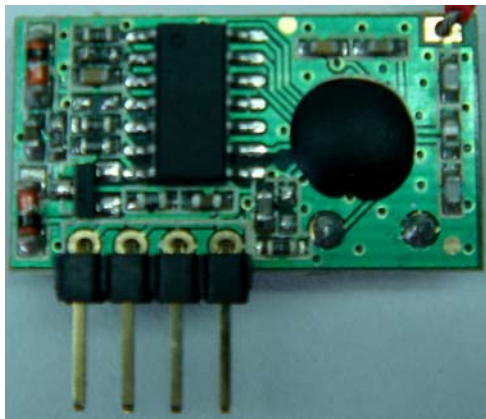

Pins name

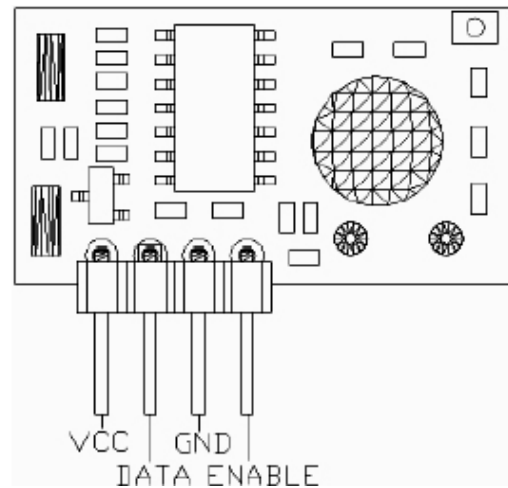

Note: ENABLE active hi make module work and low sleep the module.

It is recommended than keep ENABLE low while power on, and then active it after module initialization

Application

Pin to pin replace the old ASK module pair. Special design can be made for more sophisticated application.

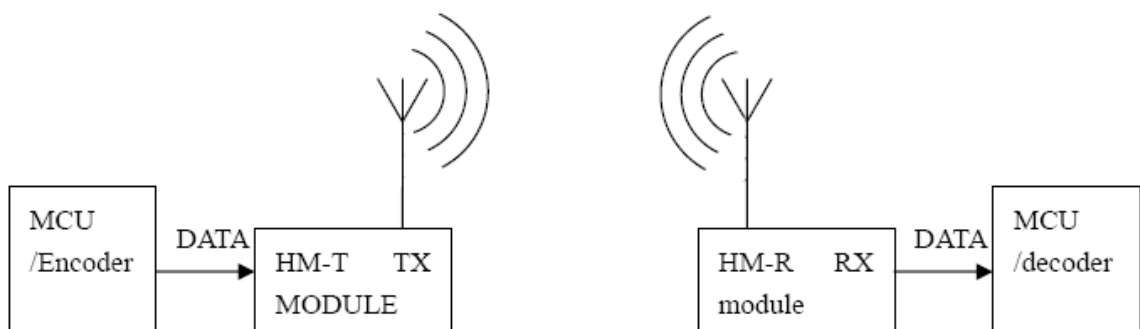

Specification

1. DC parameter

	Min	Typ	Max	Unit
Power supply	2.5	3	5	V
Temperature	-35		80	°C
Data rate	600	4800	9600	bps

Note: Data rate can be customize from 300bps to 100kpbs

2. Performance

VCC=3V, T=25°C

Model	Condition	HM-R433	HM-R868	HM-R915	单位
Frequency		434	869	915	MHz
Typical Sensitivity		-109	-105	-105	dBm
Maximum Sensitivity		-100	-98	-98	dBm
Typical RX current		10	11.5	13	mA

Note: 1.Range test conditions: 1.Open area; 2.Antenna is about 2m above ground.

2. If 5V power supplied, even longer range is possible, however more power be consumed

Naming

HM-R 433

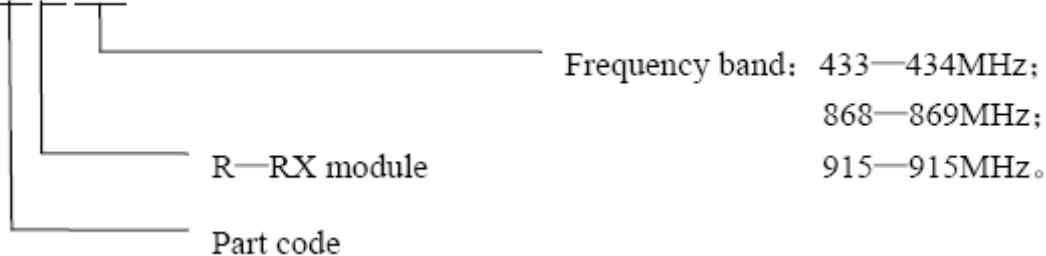

Mechanical outline

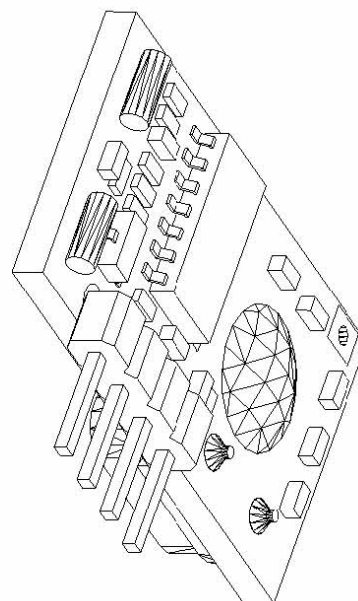
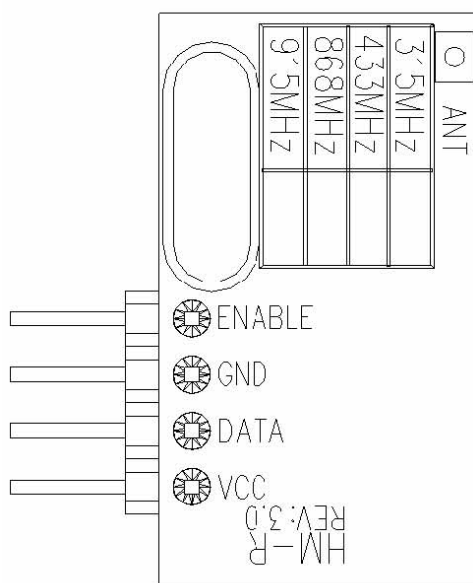
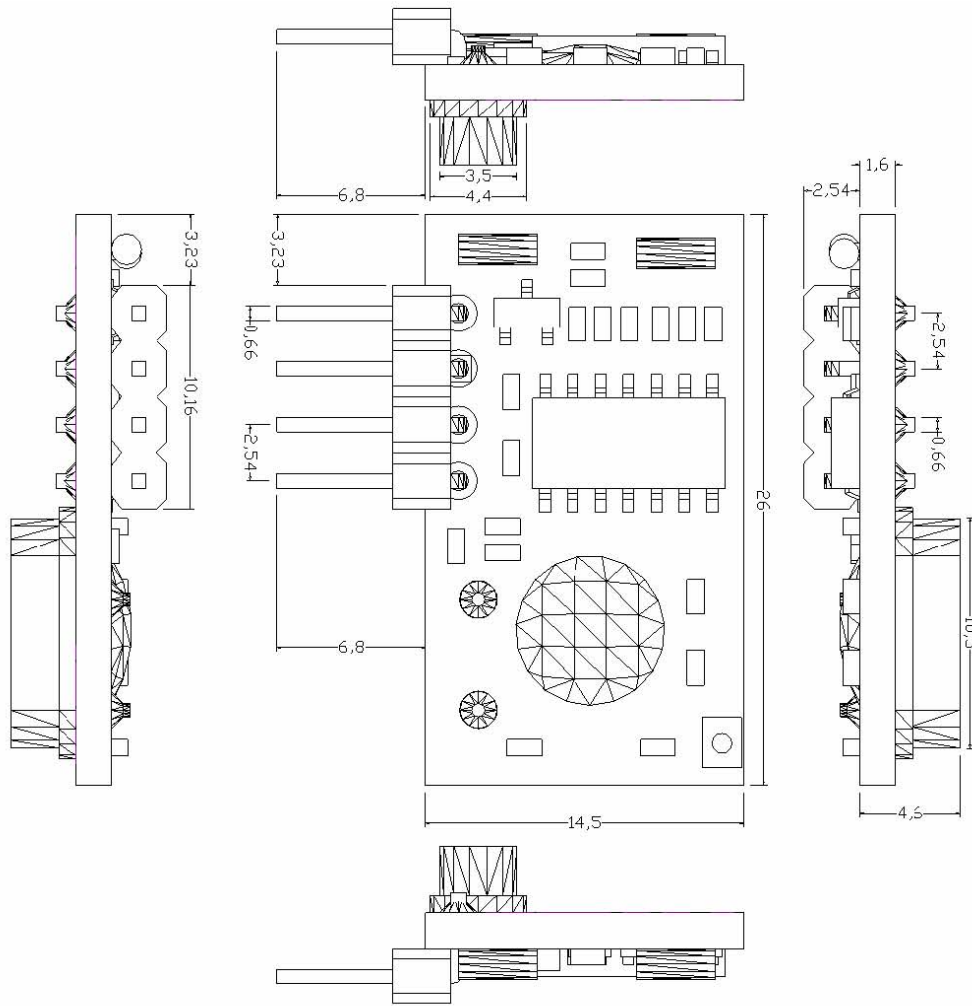

<p>HOPE MICROELECTRONICS CO.,LTD Add:4/F, Block B3, East Industrial Area, Huaqiaocheng, Shenzhen, Guangdong, China Tel: 86-755-82973805 Fax: 86-755-82973550 Email: sales@hoperf.com rade@hoperf.com Website: http://www.hoperf.com http://hoperf.en.alibaba.com</p>	<p>This document may contain preliminary information and is subject to change by Hope Microelectronics without notice. Hope Microelectronics assumes no responsibility or liability for any use of the information contained herein. Nothing in this document shall operate as an express or implied license or indemnity under the intellectual property rights of Hope Microelectronics or third parties. The products described in this document are not intended for use in implantation or other direct life support applications where malfunction may result in the direct physical harm or injury to persons. NO WARRANTIES OF ANY KIND, INCLUDING, BUT NOT LIMITED TO, THE IMPLIED WARRANTIES OF MECHANICALITY OR FITNESS FOR A PARTICULAR PURPOSE, ARE OFFERED IN THIS DOCUMENT.</p> <p>©2006, HOPE MICROELECTRONICS CO.,LTD. All rights reserved.</p>
---	--