



T-77-13

UM3561

Three Siren Sound Generator

Features

- Four sounds can be selected
- Typical 3V operating voltage
- RC oscillator with an external resistor
- A magnetic speaker can be driven by connecting an NPN transistor
- Power on reset

General Description

The UM3561 is a low-cost, low-power CMOS LSI designed for use in toy applications. Since the integrated circuit includes oscillator and selector circuits, a compact sound

module can be constructed with only a few additional components. The UM3561 contains a programmed mask ROM to simulate siren sounds.

Pin Configuration

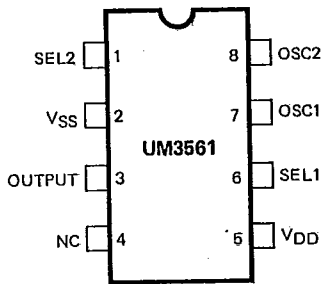

Block Diagram

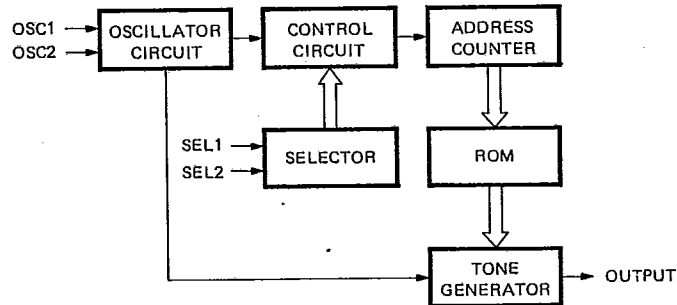

Pad Configuration

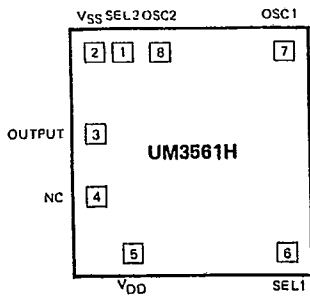



UM3561

T-77-13

Absolute Maximum Ratings*

DC Supply Voltage -0.3V to +5.0V
 Input/Output Voltage $V_{SS} - 0.3V$ to $V_{DD} + 0.3V$
 Operating Ambient Temperature -10°C to 60°C
 Storage Temperature -55°C to 125°C

***Comments**

Stresses above those listed under "Absolute Maximum Ratings" may cause permanent damage to the device. These are stress ratings only. Functional operation of this device at these or any other conditions above those indicated in the operational sections of this specification is not implied and exposure to absolute maximum rating conditions for extended periods may affect device reliability.



D.C. Electrical Characteristics ($V_{SS} = 0V$, $T_A = 25^\circ C$, $F_{OSC} = 106496$ Hz, unless otherwise specified.)

Parameter	Symbol	Min.	Typ.	Max.	Conditions
Operating Voltage	V_{DD}	2.4V	3V	3.6V	
Operating Current	I_{DD}	-	-	150µA	$V_{DD} = 3V$
"H" Input Voltage	V_{IH}	$V_{DD} - 0.2$	-	V_{DD}	
"L" Input Voltage	V_{IL}	V_{SS}	-	$V_{SS} + 0.2$	
Frequency Stability	$\Delta F/F$	-	-	20%	$\frac{F_{OSC}(3.3V) - F_{OSC}(2.7V)}{F_{OSC}(2.7V)}$
Output Current	I_O	3mA	-	-	$V_{DD} = 3V$
Frequency Deviation Per Lot	$\Delta F/F$	-10%	-	+10%	$V_{DD} = 3V$

Pin Description

Pin No.	Designation	Description
1	SEL 2	Sound effect selection pin
2	V_{SS}	Negative power supply
3	OUTPUT	Mono-tone output
4	NC	This pad is used for testing; in normal operation, this pad is open.
5	V_{DD}	Positive power supply
6	SEL 1	Sound effect selection pin
7	OSC 1	RC oscillator pin
8	OSC 2	RC oscillator pin or Inverted clock output

Functional Description

Oscillating circuit

There are two options for generating oscillator frequency. Either can be selected by changing the mask.
 (1) Only one external resistor is required to complete

the oscillator circuit.
 (2) Oscillator resistor is built-in



UM3561

T-77-13

Sound Selection

The SEL2 incorporates a resistor for internal pull low, and SEL1 is a tri-state control pin. 2 pads, SEL1 and SEL2, should be selected for the sound effect mode.

Sound Effect ROM

The sound effect ROM is organized as 256 words by 8 bits. The sound effect program and the option are mask programmable and programmed in the N⁺ layer.

Bonding Pad		Sound Effect
SEL 1	SEL 2	
No Connection	No Connection	Police Siren
V _{DD}	No Connection	Fire Engine Siren
V _{SS}	No Connection	Ambulance Siren
"-" don't care	V _{DD}	Machine Gun

Typical Application

FOUR SOUND APPLICATION

1. Police Siren 2. Fire Engine Siren 3. Ambulance Siren 4. Machine Gun

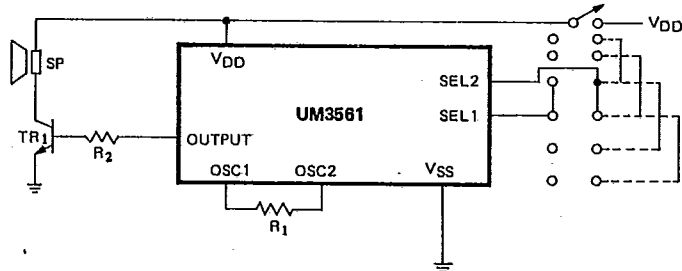

SEL1 SEL2
 (No Connection, No Connection)
 (V_{DD} No Connection)
 (V_{SS} , No Connection)
 (No Connection, V_{DD})

Recommended value:
 R₁ = 240KΩ
 R₂ = 10KΩ
 TR1: 2SC9013 or 8050
 SP: 8Ω 0.2W speaker

THREE SOUND APPLICATION

1. Police Siren 2. Fire Engine Siren 3. Ambulance Siren

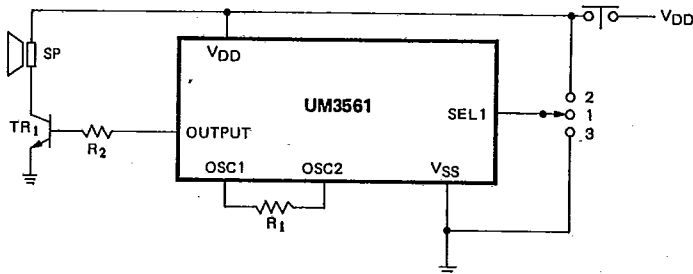

Recommended value:
 R₁ = 240KΩ
 R₂ = 10KΩ
 TR1: 2SC9013 or 8050
 SP: 8Ω 0.2W speaker

TWO SOUND APPLICATION

1. Police Siren 2. Machine Gun

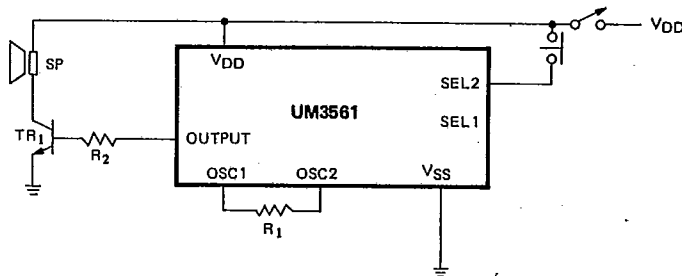

Recommended value:
 R₁ = 240KΩ
 R₂ = 10KΩ
 TR1: 2SC9013 or 8050
 SP: 8Ω 0.2W speaker



UM3561

T-77-13

Bonding Diagram

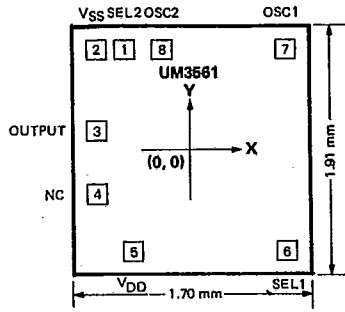

Pad No.	Designation	unit: μm	
		X	Y
1	SEL2	-266.70	777.24
2	VSS	-515.62	777.24
3	OUTPUT	-698.50	172.72
4	NC	-698.50	-370.84
5	VDD	-482.60	-767.08
6	SEL1	690.88	-762.00
7	OSC1	698.50	777.24
8	OSC2	-17.78	777.24



Ordering Information

Part Number	Package
UM3561H	Chip
UM3561	8L DIP