

TDA8950

2 × 150 W class-D power amplifier

Rev. 02 — 11 June 2009

Product data sheet

1. General description

The TDA8950 is a high-efficiency Class D audio power amplifier. The typical output power is 2 × 150 W with a speaker load impedance of 4 Ω.

The TDA8950 is available in both HSOP24 and DBS23P power packages. The amplifier operates over a wide supply voltage range from ±12.5 V to ±40 V and features low quiescent current consumption.

2. Features

- Pin compatible with TDA8920B for both HSOP24 and DBS23P packages
- Symmetrical operating supply voltage range from ±12.5 V to ±40 V
- Stereo full differential inputs, can be used as stereo Single-Ended (SE) or mono Bridge-Tied Load (BTL) amplifier
- High output power in typical applications:
 - ◆ SE 2 × 150 W, $R_L = 4 \Omega$ ($V_P = \pm 37$ V)
 - ◆ SE 2 × 170 W, $R_L = 4 \Omega$ ($V_P = \pm 39$ V)
 - ◆ SE 2 × 100 W, $R_L = 6 \Omega$ ($V_P = \pm 37$ V)
 - ◆ BTL 1 × 300 W, $R_L = 8 \Omega$ ($V_P = \pm 37$ V)
- Low noise
- Smooth pop noise-free start-up and switch off
- Zero dead time switching
- Fixed frequency
- Internal or external clock
- High efficiency
- Low quiescent current
- Advanced protection strategy: voltage protection and output current limiting
- Thermal FoldBack (TFB)
- Fixed gain of 30 dB in SE and 36 dB in BTL applications
- Fully short-circuit proof across load
- BD modulation in BTL configuration

3. Applications

- DVD
- Mini and micro receiver
- Home Theater In A Box (HTIAB) system
- High-power speaker system

4. Quick reference data

Table 1. Quick reference data

Symbol	Parameter	Conditions	Min	Typ	Max	Unit	
General, V_P[1] = ±30 V							
V_P	supply voltage	Operating mode	[2] ±12.5	±35	±40	V	
$V_{P(ovp)}$	overvoltage protection supply voltage	Standby, Mute modes; $V_{DD} - V_{SS}$	85	-	90	V	
$I_{q(tot)}$	total quiescent current	Operating mode; no load; no filter; no RC-snubber network connected	-	50	75	mA	
Stereo SE configuration							
P_o	output power	$T_j = 85\text{ °C}; L_{LC} = 22\text{ }\mu\text{H}; C_{LC} = 680\text{ nF}$ (see Figure 10)	[3]				
		THD + N = 10 %; $R_L = 4\text{ }\Omega$; $V_P = \pm 39\text{ V}$		170	-	W	
		THD + N = 0.5 %; $R_L = 4\text{ }\Omega$; $V_P = \pm 37\text{ V}$	-	100	-	W	
		THD + N = 10 %; $R_L = 4\text{ }\Omega$; $V_P = \pm 37\text{ V}$	-	150	-	W	
		THD + N = 10 %; $R_L = 6\text{ }\Omega$; $V_P = \pm 37\text{ V}$	-	100	-	W	
Mono BTL configuration							
P_o	output power	$T_j = 85\text{ °C}; L_{LC} = 22\text{ }\mu\text{H}; C_{LC} = 680\text{ nF}$ (see Figure 10); $R_L = 8\text{ }\Omega$; THD + N = 10 %; $V_P = \pm 37\text{ V}$	[3]	-	300	-	W

[1] V_P is the supply voltage on pins VDDP1, VDDP2 and VDPA.

[2] The circuit is DC adjusted at $V_P = \pm 12.5\text{ V}$ to $\pm 32.5\text{ V}$.

[3] Output power is measured indirectly; based on R_{DSon} measurement; see [Section 13.3](#).

5. Ordering information

Table 2. Ordering information

Type number	Package		Version
	Name	Description	
TDA8950J	DBS23P	plastic DIL-bent-SIL power package; 23 leads (straight lead length 3.2 mm)	SOT411-1
TDA8950TH	HSOP24	plastic, heatsink small outline package; 24 leads; low stand-off height	SOT566-3

6. Block diagram

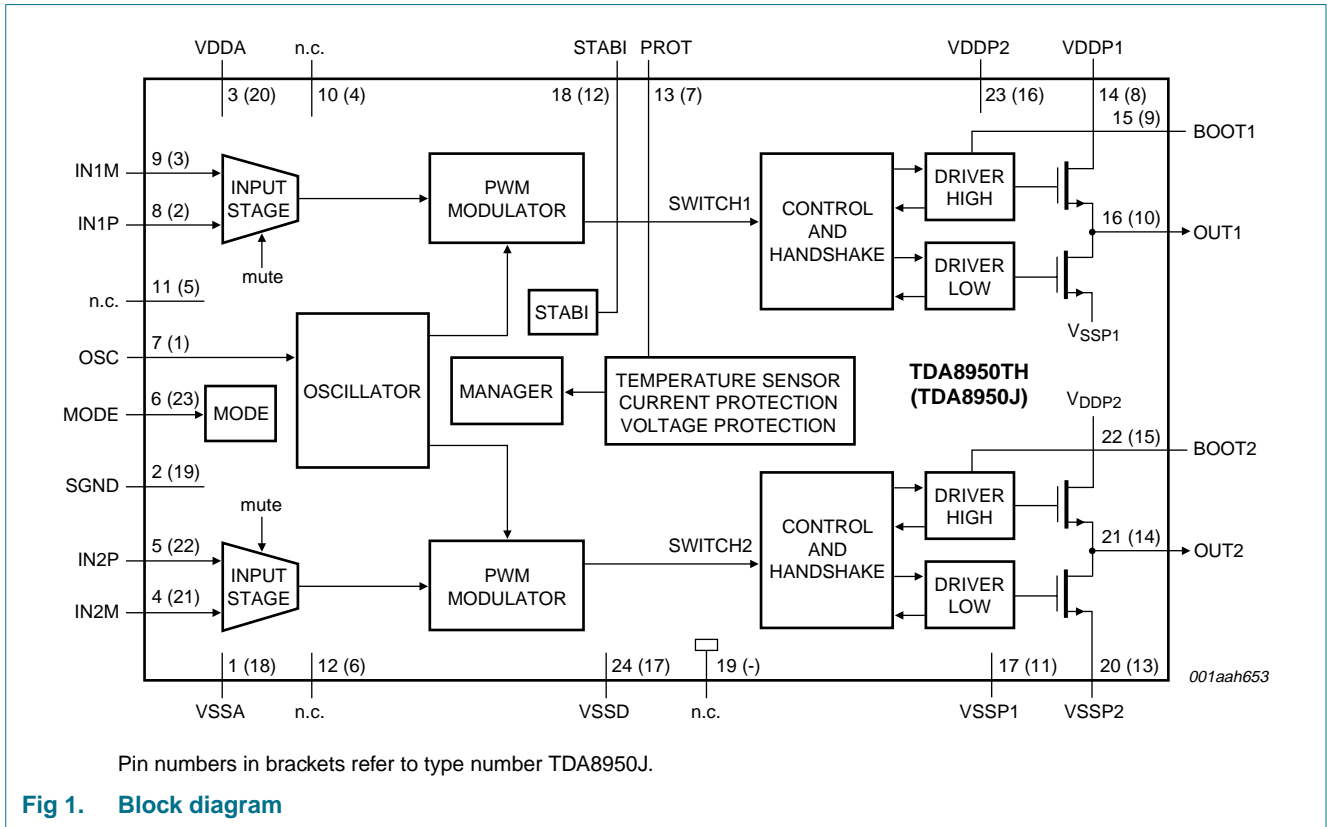

7. Pinning information

7.1 Pinning

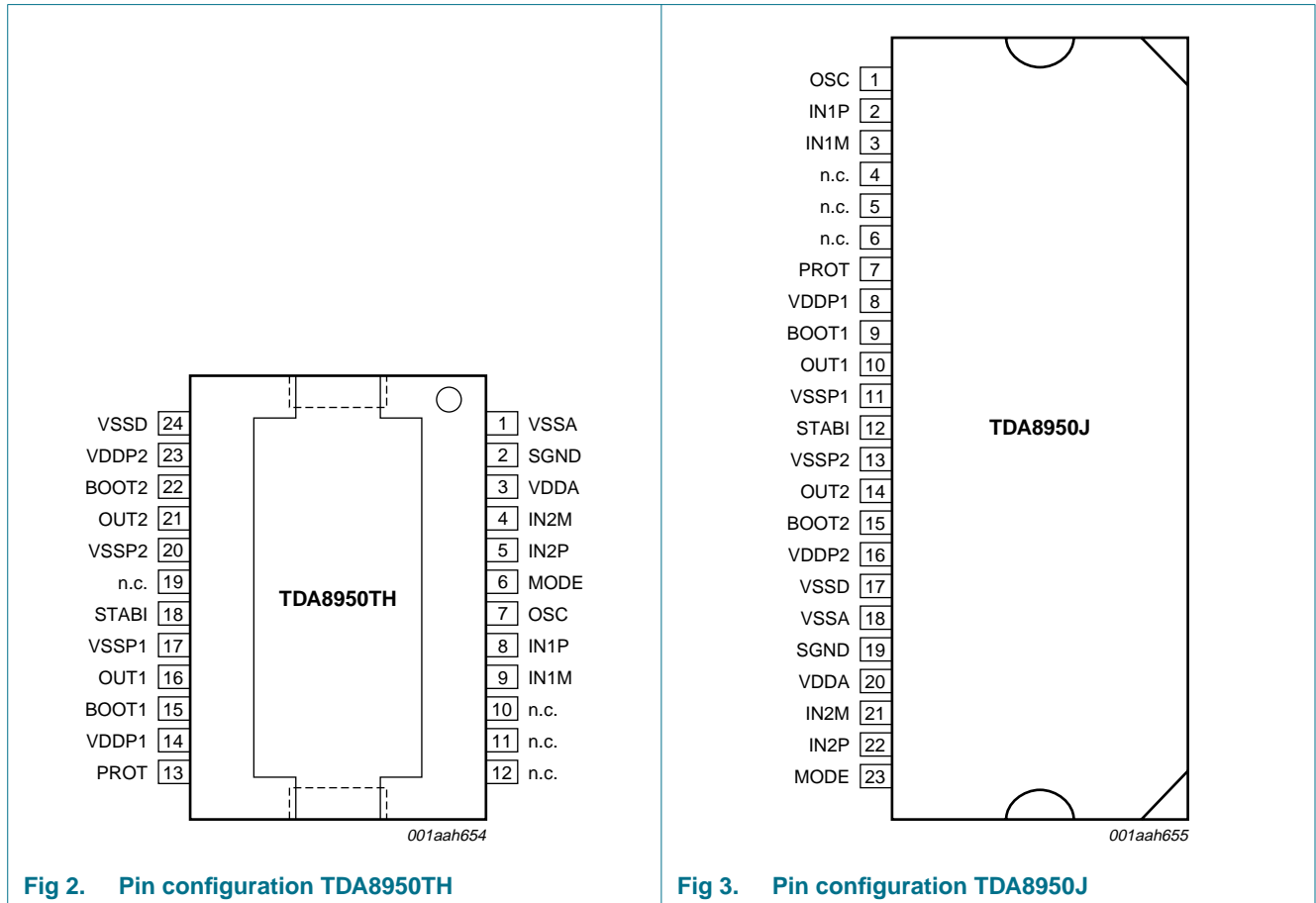

7.2 Pin description

Table 3. Pin description

Symbol	Pin		Description
	TDA8950TH	TDA8950J	
VSSA	1	18	negative analog supply voltage
SGND	2	19	signal ground
VDDA	3	20	positive analog supply voltage
IN2M	4	21	channel 2 negative audio input
IN2P	5	22	channel 2 positive audio input
MODE	6	23	mode selection input: Standby, Mute or Operating mode
OSC	7	1	oscillator frequency adjustment or tracking input
IN1P	8	2	channel 1 positive audio input
IN1M	9	3	channel 1 negative audio input
n.c.	10	4	not connected
n.c.	11	5	not connected
n.c.	12	6	not connected
PROT	13	7	decoupling capacitor for protection (OCP)
VDDP1	14	8	channel 1 positive power supply voltage
BOOT1	15	9	channel 1 bootstrap capacitor
OUT1	16	10	channel 1 PWM output
VSSP1	17	11	channel 1 negative power supply voltage
STABI	18	12	decoupling of internal stabilizer for logic supply
n.c.	19	-	not connected
VSSP2	20	13	channel 2 negative power supply voltage
OUT2	21	14	channel 2 PWM output
BOOT2	22	15	channel 2 bootstrap capacitor
VDDP2	23	16	channel 2 positive power supply voltage
VSSD	24	17	negative digital supply voltage

8. Functional description

8.1 General

The TDA8950 is a two-channel audio power amplifier that uses Class D technology.

For each channel, the audio input signal is converted into a digital PWM signal using an analog input stage and a PWM modulator; see [Figure 1](#). To drive the output power transistors, the digital PWM signal is fed to a control and handshake block and to high- and low-side driver circuits. This level-shifts the low-power digital PWM signal from a logic level to a high-power PWM signal switching between the main supply lines.

A 2nd-order low-pass filter converts the PWM signal to an analog audio signal that can be used to drive a loudspeaker.

The TDA8950 single-chip Class D amplifier contains high-power switches, drivers, timing and handshaking between the power switches, along with some control logic. To ensure maximum system robustness, an advanced protection strategy has been implemented to provide overvoltage, overtemperature and overcurrent protection.

Each of the two audio channels contains a PWM modulator, an analog feedback loop and a differential input stage. The TDA8950 also contains circuits common to both channels such as the oscillator, all reference sources, the mode interface and a digital timing manager.

The two independent amplifier channels feature high output power, high efficiency, low distortion and low quiescent currents, and can be connected in the following configurations:

- Stereo Single-Ended (SE)
- Mono Bridge-Tied Load (BTL)

The amplifier system can be switched to one of three operating modes using pin MODE:

- Standby mode: featuring very low quiescent current
- Mute mode: the amplifier is operational but the audio signal at the output is suppressed by disabling the voltage-to-current (VI converter) input stages
- Operating mode: the amplifier is fully operational, de-muted and can deliver an output signal

A slowly rising voltage should be applied (e.g. via an RC network) to pin MODE to ensure pop noise-free start-up. The bias-current setting of the (VI converter) input stages is related to the voltage on the MODE pin.

In Mute mode, the bias-current setting of the VI converters is zero (VI converters are disabled). In Operating mode, the bias current is at a maximum. The time constant required to apply the DC output offset voltage gradually between Mute and Operating mode levels can be generated using an RC network connected to pin MODE. An example of a switching circuit for driving pin MODE is illustrated in [Figure 4](#). If the capacitor was omitted, the very short switching time constant could result in audible pop noises being generated at start-up (depending on the DC output offset voltage and loudspeaker used).

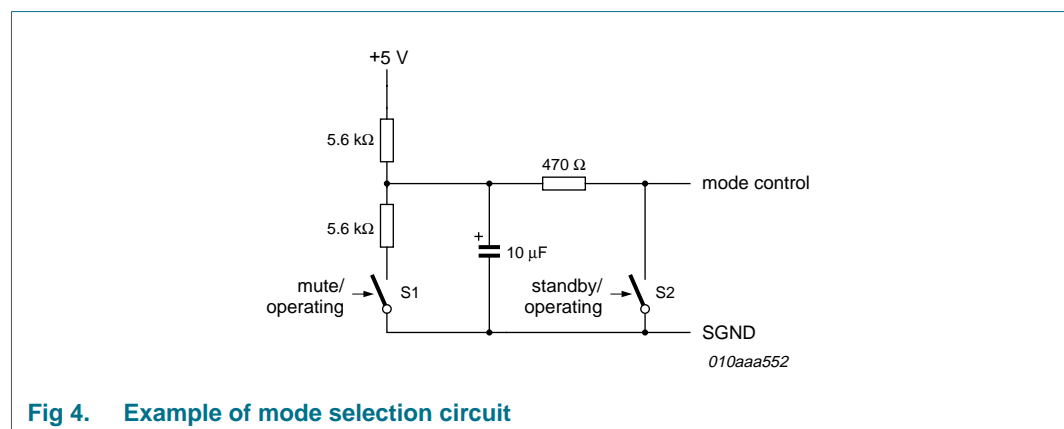
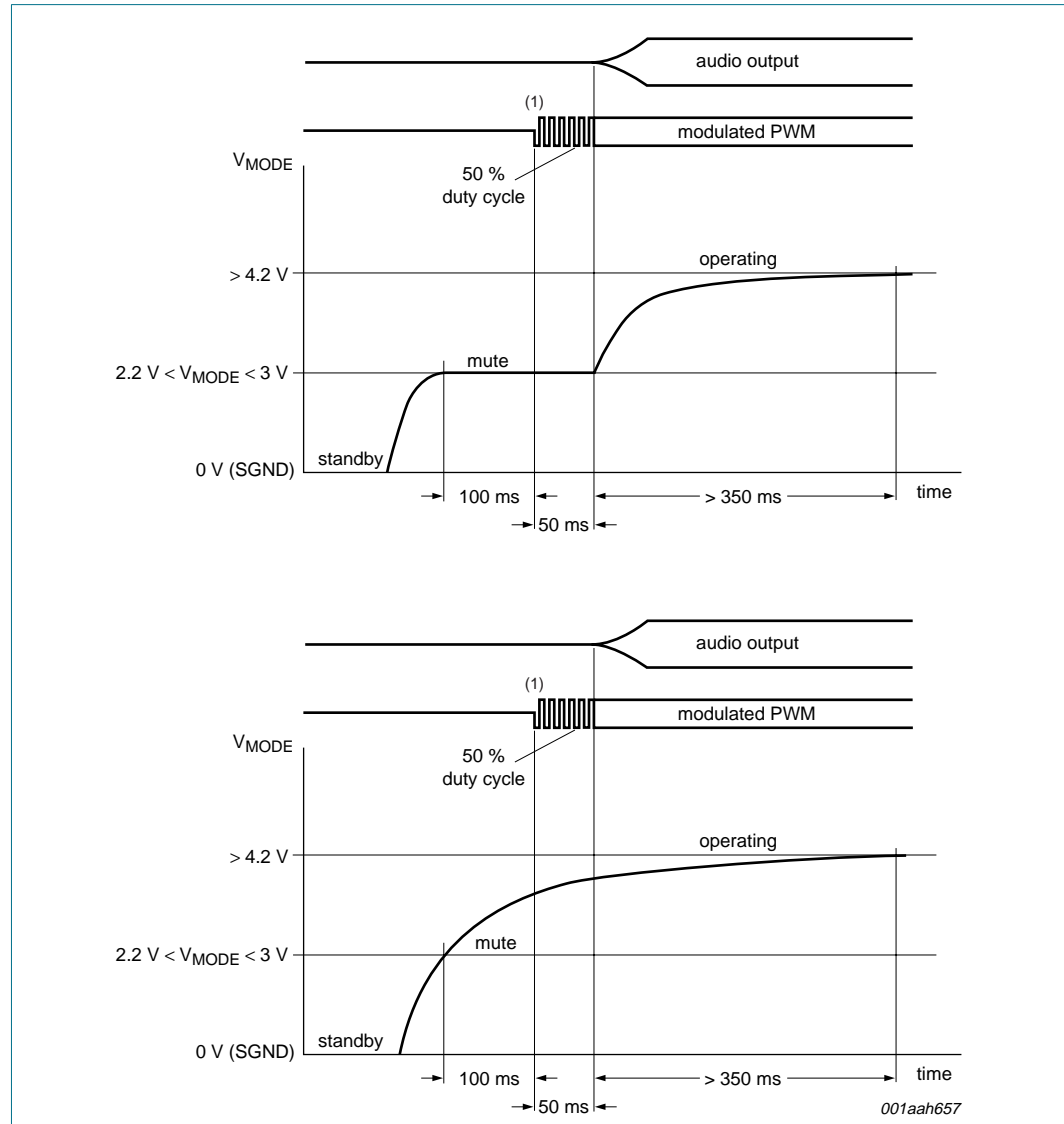

Fig 4. Example of mode selection circuit

To ensure the coupling capacitors at the inputs (C_{IN} in [Figure 10](#)) are fully charged before the outputs start switching, a delay is inserted during the transition from Mute to Operating mode. An overview of the start-up timing is provided in [Figure 5](#). For proper switch-off, the MODE pin should be forced LOW at least 100 ms before the supply lines (V_{DDA} and V_{SSA}) drop below 12.5 V.



(1) First 1/4 pulse down.

Upper diagram: When switching from Standby to Mute, there is a delay of approximately 100 ms before the output starts switching. The audio signal will become available once V_{MODE} reaches the Operating mode level (see [Table 8](#)), but not earlier than 150 ms after switching to Mute. To start-up pop noise-free, it is recommended that the time constant applied to pin MODE be at least 350 ms for the transition between Mute and Operating modes.

Lower diagram: When switching directly from Standby to Operating mode, there is a delay of 100 ms before the outputs start switching. The audio signal becomes available after a second delay of 50 ms. To start-up pop noise-free, it is recommended that the time-constant applied to pin MODE be at least 500 ms for the transition between Standby and Operating modes.

Fig 5. Timing on mode selection input pin MODE

8.2 Pulse-width modulation frequency

The amplifier output signal is a PWM signal with a typical carrier frequency of between 250 kHz and 450 kHz. A 2nd-order LC demodulation filter on the output is used to convert the PWM signal into an analog audio signal. The carrier frequency is determined by an external resistor, R_{OSC} , connected between pins OSC and VSSA. The optimal carrier frequency setting is between 250 kHz and 450 kHz.

The carrier frequency is set to 345 kHz by connecting an external 30 k Ω resistor between pins OSC and VSSA. See [Table 9](#) for more details.

If two or more Class D amplifiers are used in the same audio application, it is recommended that an external clock circuit be used with all devices (see [Section 13.4](#)). This will ensure that they operate at the same switching frequency, thus avoiding beat tones (if the switching frequencies are different, audible interference known as 'beat tones' can be generated)

8.3 Protection

The following protection circuits are incorporated into the TDA8950:

- Thermal protection:
 - Thermal FoldBack (TFB)
 - OverTemperature Protection (OTP)
- OverCurrent Protection (OCP)
- Window Protection (WP)
- Supply voltage protection:
 - UnderVoltage Protection (UVP)
 - OverVoltage Protection (OVP)
 - UnBalance Protection (UBP)

How the device reacts to a fault conditions depends on which protection circuit has been activated.

8.3.1 Thermal protection

The TDA8950 employs an advanced thermal protection strategy. A TFB function gradually reduces the output power within a defined temperature range. If the temperature continues to rise, OTP is activated to shut down the device completely.

8.3.1.1 Thermal FoldBack (TFB)

If the junction temperature (T_j) exceeds the thermal foldback activation threshold, the gain is gradually reduced. This reduces the output signal amplitude and the power dissipation, eventually stabilizing the temperature.

TFB is specified at the thermal foldback activation temperature $T_{act(th_fold)}$ where the closed-loop voltage gain is reduced by 6 dB. The TFB range is:

$$T_{act(th_fold)} - 5\text{ }^{\circ}\text{C} < T_{act(th_fold)} < T_{act(th_prot)}$$

The value of $T_{act(th_fold)}$ for the TDA8950 is approximately 153 $^{\circ}\text{C}$; see [Table 8](#) for more details.

8.3.1.2 OverTemperature Protection (OTP)

If TFB fails to stabilize the temperature and the junction temperature continues to rise, the amplifier will shut down as soon as the temperature reaches the thermal protection activation threshold, $T_{act(th_prot)}$. The amplifier will resume switching approximately 100 ms after the temperature drops below $T_{act(th_prot)}$.

The thermal behavior is illustrated in [Figure 6](#).

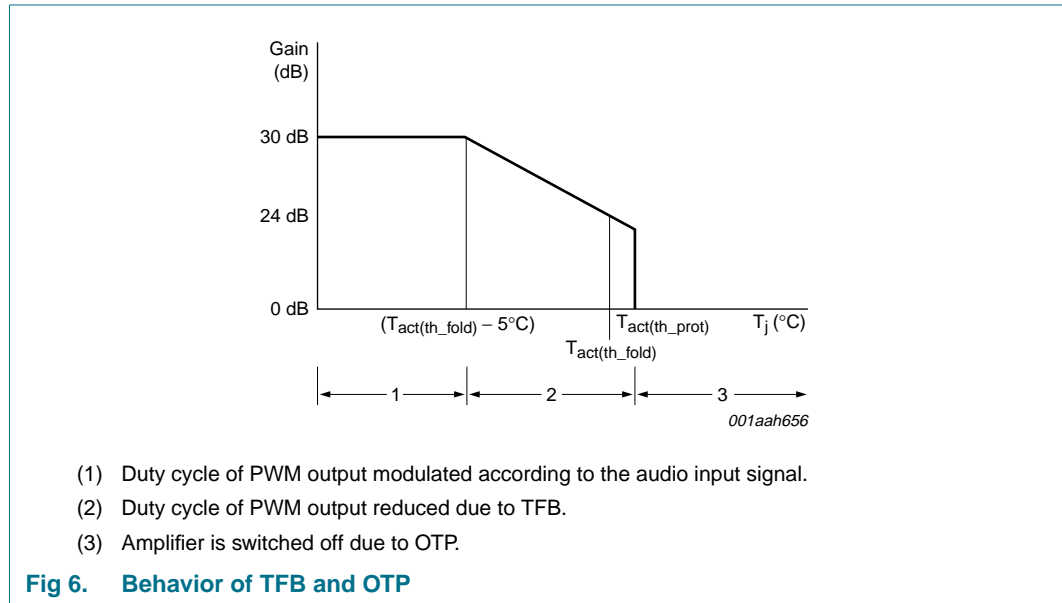

8.3.2 OverCurrent Protection (OCP)

In order to guarantee the robustness of the TDA8950, the maximum output current that can be delivered at the output stages is limited. OCP is built in for each output power switch.

OCP is activated when the current in one of the power transistors exceeds the OCP threshold ($I_{ORM} = 9.2\text{ A}$) due, for example, to a short-circuit to a supply line or across the load.

The TDA8950 amplifier distinguishes between low-ohmic short-circuit conditions and other overcurrent conditions such as a dynamic impedance drop at the loudspeaker. The impedance threshold (Z_{th}) depends on the supply voltage.

How the amplifier reacts to a short circuit depends on the short-circuit impedance:

- Short-circuit impedance > Z_{th} : the amplifier limits the maximum output current to I_{ORM} but the amplifier does not shut down the PWM outputs. Effectively, this results in a clipped output signal across the load (behavior very similar to voltage clipping).
- Short-circuit impedance < Z_{th} : the amplifier limits the maximum output current to I_{ORM} and at the same time discharges the capacitor on pin PROT. When C_{PROT} is fully discharged, the amplifier shuts down completely and an internal timer is started.

The value of the protection capacitor (C_{PROT}) connected to pin PROT can be between 10 pF and 220 pF (typically 47 pF). While OCP is activated, an internal current source is enabled that will discharge C_{PROT} .

When OCP is activated, the power transistors are turned off. They are turned on again during the next switching cycle. If the output current is still greater than the OCP threshold, they will be immediately switched off again. This switching will continue until C_{PROT} is fully discharged. The amplifier will then be switched off completely and a restart sequence initiated.

After a fixed period of 100 ms, the amplifier will attempt to switch on again, but will fail if the output current still exceeds the OCP threshold. The amplifier will continue trying to switch on every 100 ms. The average power dissipation will be low in this situation because the duty cycle is low.

Switching the amplifier on and off in this way will generate unwanted ‘audio holes’. This can be avoided by increasing the value of C_{PROT} (up to 220 pF) to delay amplifier switch-off. C_{PROT} will also prevent the amplifier switching off due to transient frequency-dependent impedance drops at the speakers.

The amplifier will switch on, and remain in Operating mode, once the overcurrent condition has been removed. OCP ensures the TDA8950 amplifier is fully protected against short-circuit conditions while avoiding audio holes.

Table 4. Current limiting behavior during low output impedance conditions at different values of C_{PROT}

Type	V _p [1] (V)	V _I (mV, p-p)	f (Hz)	C _{PROT} (pF)	PWM output stops		
					Short (Z _{th} = 0 Ω)	Short (Z _{th} = 0.5 Ω)	Short (Z _{th} = 1 Ω)
TDA8950	29.5	500	20	10	yes	yes	OVP[2]
				1000	10	yes	yes
			1000	15	yes	yes	OVP[2]
				15	yes	no	no
			1000	220	no	no	no

[1] V_p is the supply voltage on pins VDDP1, VDDP2 and VDDA.

[2] OVP can be triggered by supply pumping; see [Section 13.6](#).

8.3.3 Window Protection (WP)

Window Protection (WP) checks the conditions at the output terminals of the power stage and is activated:

- During the start-up sequence, when the TDA8950 is switching from Standby to Mute. Start-up will be interrupted if a short-circuit is detected between one of the output terminals and pin VDDP1/VDDP2 or VSSP1/VSSP2. The TDA8950 will wait until the short-circuit to the supply lines has been removed before resuming start-up. The short circuit will not generate large currents because the short-circuit check is carried out before the power stages are enabled.
- When the amplifier is shut down completely because the OCP circuit has detected a short circuit to one of the supply lines.
 WP will be activated when the amplifier attempts to restart after 100 ms (see [Section 8.3.2](#)). The amplifier will not start-up again until the short circuit to the supply lines has been removed.

8.3.4 Supply voltage protection

If the supply voltage drops below the minimum supply voltage threshold, $V_{P(uvp)}$, the UVP circuit will be activated and the system will shut down. Once the supply voltage rises above $V_{P(uvp)}$ again, the system will restart after a delay of 100 ms.

If the supply voltage exceeds the maximum supply voltage threshold, $V_{P(ovp)}$, the OVP circuit will be activated and the power stages will be shut down. When the supply voltage drops below $V_{P(ovp)}$ again, the system will restart after a delay of 100 ms.

An additional UnBalance Protection (UBP) circuit compares the positive analog supply voltage (on pin VDDA) with the negative analog supply voltage (on pin VSSA) and is triggered if the voltage difference exceeds a factor of two ($V_{DDA} > 2 \times |V_{SSA}|$ OR $|V_{SSA}| > 2 \times V_{DDA}$). When the supply voltage difference drops below the unbalance threshold, $V_{P(ubp)}$, the system restarts after 100 ms.

An overview of all protection circuits and their respective effects on the output signal is provided in [Table 5](#).

Table 5. Overview of TDA8950 protection circuits

Protection name	Complete shutdown	Restart directly	Restart after 100 ms	Pin PROT detection
TFB ^[1]	N	N	N	N
OTP	Y	N	Y	N
OCP	Y ^[2]	N ^[2]	Y ^[2]	Y
WP	N ^[3]	Y	N	N
UVP	Y	N	Y	N
OVP	Y	N	Y	N
UBP	Y	N	Y	N

[1] Amplifier gain depends on the junction temperature and heatsink size.

[2] The amplifier shuts down completely only if the short-circuit impedance is below the impedance threshold (Z_{th} ; see [Section 8.3.2](#)). In all other cases, current limiting results in a clipped output signal.

[3] Fault condition detected during any Standby-to-Mute transition or during a restart after OCP has been activated (short-circuit to one of the supply lines).

8.4 Differential audio inputs

The audio inputs are fully differential ensuring a high common mode rejection ratio and maximum flexibility in the application.

- Stereo operation: to avoid acoustical phase differences, the inputs should be in antiphase and the speakers should be connected in antiphase. This configuration:
 - minimizes power supply peak current
 - minimizes supply pumping effects, especially at low audio frequencies
- Mono BTL operation: the inputs must be connected in anti-parallel. The output of one channel is inverted and the speaker load is connected between the two outputs of the TDA8950. In practice (because of the OCP threshold) the output power can be boosted to twice the output power that can be achieved with the single-ended configuration.

The input configuration for a mono BTL application is illustrated in [Figure 7](#).

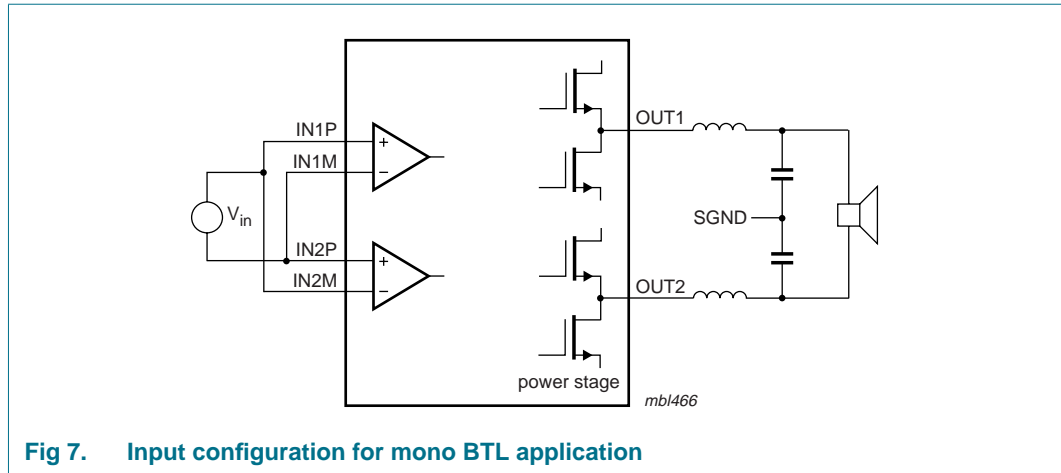

Fig 7. Input configuration for mono BTL application

9. Limiting values

Table 6. Limiting values

In accordance with the Absolute Maximum Rating System (IEC 60134).

Symbol	Parameter	Conditions	Min	Max	Unit
V_P ^[1]	supply voltage	Standby, Mute modes; $V_{DD} - V_{SS}$	-	90	V
I_{ORM}	repetitive peak output current	maximum output current limiting	9.2	-	A
T_{stg}	storage temperature		-55	+150	°C
T_{amb}	ambient temperature		-40	+85	°C
T_j	junction temperature		-	150	°C
V_{MODE}	voltage on pin MODE	referenced to SGND	0	6	V
V_{OSC}	voltage on pin OSC		0	SGND + 6	V
V_I	input voltage	referenced to SGND; pin IN1P; IN1M; IN2P and IN2M	-5	+5	V
V_{PROT}	voltage on pin PROT	referenced to voltage on pin VSSD	0	12	V
V_{ESD}	electrostatic discharge voltage	Human Body Model (HBM)	-2000	+2000	V
		Charged Device Model (CDM)	-500	+500	V
$I_{q(tot)}$	total quiescent current	Operating mode; no load; no filter; no RC-snubber network connected	-	75	mA
$V_{PWM(p-p)}$	peak-to-peak PWM voltage	on pins OUT1 and OUT2	-	120	V

[1] V_P is the supply voltage on pins VDDP1, VDDP2 and VDDA.

10. Thermal characteristics

Table 7. Thermal characteristics

Symbol	Parameter	Conditions	Typ	Unit
$R_{th(j-a)}$	thermal resistance from junction to ambient	in free air	40	K/W
$R_{th(j-c)}$	thermal resistance from junction to case		1.1	K/W

11. Static characteristics

Table 8. Static characteristics

$V_P = \pm 35\text{ V}$; $f_{osc} = 345\text{ kHz}$; $T_{amb} = 25\text{ °C}$; unless otherwise specified.

Symbol	Parameter	Conditions	Min	Typ	Max	Unit
Supply						
V_P [1]	supply voltage	Operating mode	[2] ± 12.5	± 30	± 40	V
$V_{P(ovp)}$	overvoltage protection supply voltage	Standby, Mute modes; $V_{DD} - V_{SS}$	85	-	90	V
$V_{P(uvp)}$	undervoltage protection supply voltage	$V_{DD} - V_{SS}$	20	-	25	V
$V_{P(ubp)}$	unbalance protection supply voltage		[3] -	33	-	%
$I_{q(tot)}$	total quiescent current	Operating mode; no load; no filter; no RC-snubber network connected	-	50	75	mA
I_{stb}	standby current	measured at 30 V	-	480	650	μA
Mode select input; pin MODE						
V_{MODE}	voltage on pin MODE	referenced to SGND	[4] 0	-	6	V
		Standby mode	[4][5] 0	-	0.8	V
		Mute mode	[4][5] 2.2	-	3.0	V
		Operating mode	[4][5] 4.2	-	6	V
I_I	input current	$V_I = 5.5\text{ V}$	-	110	150	μA
Audio inputs; pins IN1M, IN1P, IN2P and IN2M						
V_I	input voltage	DC input	[4] -	0	-	V
Amplifier outputs; pins OUT1 and OUT2						
$V_{O(offset)}$	output offset voltage	SE; Mute mode	-	-	± 25	mV
		SE; Operating mode	[6] -	-	± 150	mV
		BTL; Mute mode	-	-	± 30	mV
		BTL; Operating mode	[6] -	-	± 210	mV
Stabilizer output; pin STABI						
$V_{O(STABI)}$	output voltage on pin STABI	Mute and Operating modes; with respect to VSSD	9.3	9.8	10.3	V
Temperature protection						
$T_{act(th_prot)}$	thermal protection activation temperature		-	154	-	$^{\circ}\text{C}$
$T_{act(th_fold)}$	thermal foldback activation temperature	closed loop SE voltage gain reduced with 6 dB	[7] -	153	-	$^{\circ}\text{C}$

[1] V_P is the supply voltage on pins VDDP1, VDDP2 and VDPA.

[2] The circuit is DC adjusted at $V_P = \pm 12.5\text{ V}$ to $\pm 42.5\text{ V}$.

[3] Unbalance protection activated when $V_{DDA} > 2 \times |V_{SSA}|$ OR $|V_{SSA}| > 2 \times V_{DDA}$.

[4] With respect to SGND (0 V).

[5] The transition between Standby and Mute modes has hysteresis, while the slope of the transition between Mute and Operating modes is determined by the time-constant of the RC network on pin MODE; see [Figure 8](#).

[6] DC output offset voltage is gradually applied to the output during the transition between Mute and Operating modes. The slope caused by any DC output offset is determined by the time-constant of the RC network on pin MODE.

[7] At a junction temperature of approximately $T_{act(th_fold)} - 5\text{ °C}$, gain reduction commences and at a junction temperature of approximately $T_{act(th_prot)}$, the amplifier switches off.

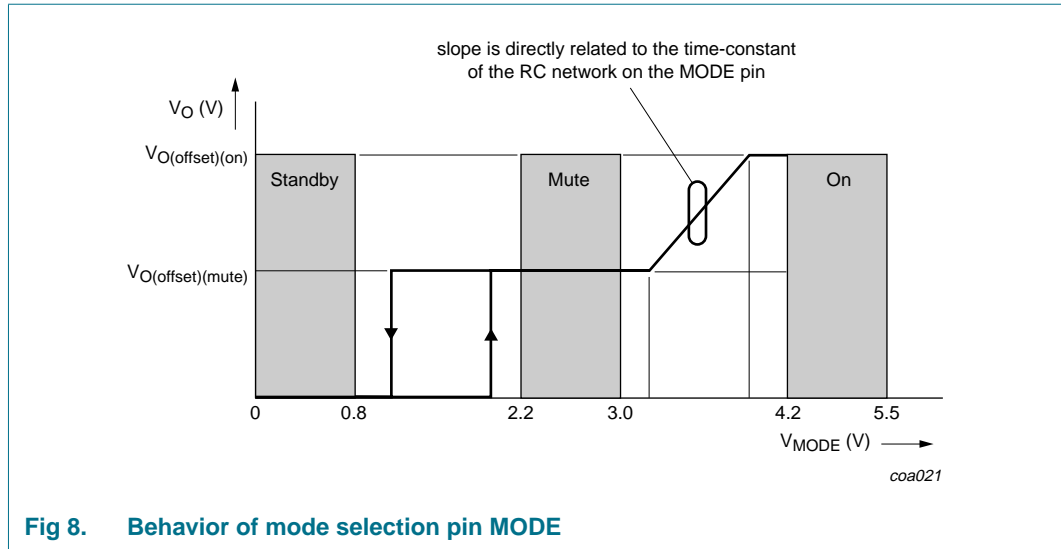

Fig 8. Behavior of mode selection pin MODE

12. Dynamic characteristics

12.1 Switching characteristics

Table 9. Dynamic characteristics

$V_P^{[1]} = \pm 35\text{ V}$; $T_{amb} = 25\text{ }^\circ\text{C}$; unless otherwise specified.

Symbol	Parameter	Conditions	Min	Typ	Max	Unit
Internal oscillator						
$f_{osc(typ)}$	typical oscillator frequency	$R_{OSC} = 30.0\text{ k}\Omega$	290	345	365	kHz
f_{osc}	oscillator frequency		250	-	450	kHz
External oscillator input or frequency tracking; pin OSC						
V_{OSC}	voltage on pin OSC	HIGH-level	SGND + 4.5	SGND + 5	SGND + 6	V
V_{trip}	trip voltage		-	SGND + 2.5	-	V
f_{track}	tracking frequency		[2] 500	-	900	kHz
Z_i	input impedance		1	-	-	M Ω
C_i	input capacitance		-	-	15	pF
$t_{r(i)}$	input rise time	from SGND + 0 V SGND + 5 V	[3] -	-	100	ns

[1] V_P is the supply voltage on pins VDDP1, VDDP2 and VDDA.

[2] When using an external oscillator, the frequency f_{track} (500 kHz minimum, 900 kHz maximum) will result in a PWM frequency f_{osc} (250 kHz minimum, 450 kHz maximum) due to the internal clock divider; see [Section 8.2](#).

[3] When $t_{r(i)} > 100\text{ ns}$, the output noise floor will increase.

12.2 Stereo SE configuration characteristics

Table 10. Dynamic characteristics

V_P ^[1] = ±35 V; R_L = 4 Ω; f_i = 1 kHz; f_{osc} = 345 kHz; R_{sL} ^[2] < 0.1 Ω; T_{amb} = 25 °C; unless otherwise specified.

Symbol	Parameter	Conditions	Min	Typ	Max	Unit	
P _o	output power	T _j = 85 °C; L _{LC} = 22 μH; C _{LC} = 680 nF (see Figure 10)	[3]				
		THD + N = 10 %; R _L = 4 Ω; V _P = ±39 V		170		W	
		THD + N = 0.5 %; R _L = 4 Ω; V _P = ±37 V	-	100	-	W	
		THD + N = 10 %; R _L = 4 Ω; V _P = ±37 V	-	150	-	W	
		THD + N = 10 %; R _L = 6 Ω; V _P = ±37 V	-	100	-	W	
THD	total harmonic distortion	P _o = 1 W; f _i = 1 kHz	[4]	-	0.05	-	%
		P _o = 1 W; f _i = 6 kHz	[4]	-	0.05	-	%
G _{v(cl)}	closed-loop voltage gain		29	30	31	dB	
SVRR	supply voltage ripple rejection	between pins VDDPn and SGND					
		Operating mode; f _i = 100 Hz	[5]	-	90	-	dB
		Operating mode; f _i = 1 kHz	[5]	-	70	-	dB
		Mute mode; f _i = 100 Hz	[5]	-	75	-	dB
		Standby mode; f _i = 100 Hz	[5]	-	120	-	dB
		between pins VSSPn and SGND					
		Operating mode; f _i = 100 Hz	[5]	-	80	-	dB
		Operating mode; f _i = 1 kHz	[5]	-	60	-	dB
		Mute mode; f _i = 100 Hz	[5]	-	80	-	dB
		Standby mode; f _i = 100 Hz	[5]	-	115	-	dB
Z _i	input impedance	between one of the input pins and SGND	45	63	-	kΩ	
V _{n(o)}	output noise voltage	Operating mode; R _s = 0 Ω	[6]	-	160	-	μV
		Mute mode	[7]	-	85	-	μV
α _{cs}	channel separation		[8]	-	70	-	dB
ΔG _v	voltage gain difference		-	-	1	dB	
α _{mute}	mute attenuation	f _i = 1 kHz; V _i = 2 V (RMS)	[9]	-	75	-	dB
CMRR	common mode rejection ratio	V _{i(CM)} = 1 V (RMS)	-	75	-	dB	
η _{po}	output power efficiency	SE, R _L = 4 Ω	-	88	-	%	
		SE, R _L = 6 Ω	-	90	-	%	
		BTL, R _L = 8 Ω	-	88	-	%	
R _{DSon(hs)}	high-side drain-source on-state resistance		[10]	-	200	-	mΩ
R _{DSon(ls)}	low-side drain-source on-state resistance		[10]	-	190	-	mΩ

[1] V_P is the supply voltage on pins VDDP1, VDDP2 and VDDA.

[2] R_{sL} is the series resistance of the low-pass LC filter inductor used in the application.

[3] Output power is measured indirectly; based on R_{DSon} measurement; see Section 13.3.

[4] THD measured between 22 Hz and 20 kHz, using AES17 20 kHz brick wall filter; max. limit is guaranteed but may not be 100 % tested.

[5] V_{ripple} = V_{ripple(max)} = 2 V (p-p); measured independently between VDDPn and SGND and between VSSPn and SGND.

[6] 22 Hz to 20 kHz, using AES17 20 kHz brick wall filter.

[7] 22 Hz to 20 kHz, using AES17 20 kHz brick wall filter.

- [8] $P_o = 1\text{ W}$; $f_i = 1\text{ kHz}$.
- [9] $V_i = V_{i(\text{max})} = 1\text{ V (RMS)}$; $f_i = 1\text{ kHz}$.
- [10] Leads and bond wires included.

12.3 Mono BTL application characteristics

Table 11. Dynamic characteristics

V_P [1] = ±35 V; $R_L = 8\ \Omega$; $f_i = 1\text{ kHz}$; $f_{osc} = 345\text{ kHz}$; R_{sL} [2] < 0.1 Ω; $T_{amb} = 25\text{ °C}$; unless otherwise specified.

Symbol	Parameter	Conditions	Min	Typ	Max	Unit	
P_o	output power	$T_j = 85\text{ °C}$; $L_{LC} = 22\ \mu\text{H}$; $C_{LC} = 680\text{ nF}$ (see Figure 10)	[3]				
		THD + N = 10 %; $R_L = 8\ \Omega$; $V_P = \pm 39\text{ V}$	-	340	-	W	
		THD + N = 0.5 %; $R_L = 8\ \Omega$; $V_P = \pm 37\text{ V}$	-	200	-	W	
		THD + N = 10 %; $R_L = 8\ \Omega$; $V_P = \pm 37\text{ V}$	-	300	-	W	
THD	total harmonic distortion	$P_o = 1\text{ W}$; $f_i = 1\text{ kHz}$	[4]	-	0.05	-	%
		$P_o = 1\text{ W}$; $f_i = 6\text{ kHz}$	[4]	-	0.05	-	%
$G_{V(\text{cl})}$	closed-loop voltage gain		-	36	-	dB	
SVRR	supply voltage ripple rejection	between pin VDDPn and SGND					
		Operating mode; $f_i = 100\text{ Hz}$	[5]	-	80	-	dB
		Operating mode; $f_i = 1\text{ kHz}$	[5]	-	80	-	dB
		Mute mode; $f_i = 100\text{ Hz}$	[5]	-	95	-	dB
		Standby mode; $f_i = 100\text{ Hz}$	[5]	-	120	-	dB
		between pin VSSPn and SGND					
		Operating mode; $f_i = 100\text{ Hz}$	[5]	-	75	-	dB
		Operating mode; $f_i = 1\text{ kHz}$	[5]	-	75	-	dB
		Mute mode; $f_i = 100\text{ Hz}$	[5]	-	90	-	dB
		Standby mode; $f_i = 100\text{ Hz}$	[5]	-	130	-	dB
Z_i	input impedance	measured between one of the input pins and SGND	45	63	-	kΩ	
$V_{n(o)}$	output noise voltage	Operating mode; $R_s = 0\ \Omega$	[6]	-	190	-	μV
		Mute mode	[7]	-	45	-	μV
α_{mute}	mute attenuation	$f_i = 1\text{ kHz}$; $V_i = 2\text{ V (RMS)}$	[8]	-	75	-	dB
CMRR	common mode rejection ratio	$V_{i(\text{CM})} = 1\text{ V (RMS)}$	-	75	-	dB	

- [1] V_P is the supply voltage on pins VDDP1, VDDP2 and VDPA.
- [2] R_{sL} is the series resistance of the low-pass LC filter inductor used in the application.
- [3] Output power is measured indirectly; based on R_{DSon} measurement; see Section 13.3.
- [4] THD measured between 22 Hz and 20 kHz, using AES17 20 kHz brick wall filter; max. limit is guaranteed but may not be 100 % tested.
- [5] $V_{\text{ripple}} = V_{\text{ripple(max)}} = 2\text{ V (p-p)}$.
- [6] 22 Hz to 20 kHz, using an AES17 20 kHz brick wall filter; low noise due to BD modulation.
- [7] 22 Hz to 20 kHz, using an AES17 20 kHz brick wall filter.
- [8] $V_i = V_{i(\text{max})} = 1\text{ V (RMS)}$; $f_i = 1\text{ kHz}$.

13. Application information

13.1 Mono BTL application

When using the power amplifier in a mono BTL application, the inputs of the two channels must be connected in parallel and the phase of one of the inputs must be inverted; see [Figure 7](#). In principle, the loudspeaker can be connected between the outputs of the two single-ended demodulation filters.

13.2 Pin MODE

To ensure a pop noise-free start-up, an RC time-constant must be applied to pin MODE. The bias-current setting of the VI converter input is directly related to the voltage on pin MODE. In turn the bias-current setting of the VI converters is directly related to the DC output offset voltage. A slow dV/dt on pin MODE results in a slow dV/dt for the DC output offset voltage, ensuring a pop noise-free transition between Mute and Operating modes. A time-constant of 500 ms is sufficient to guarantee pop noise-free start-up; see [Figure 4](#), [Figure 5](#) and [Figure 8](#) for more information.

13.3 Estimating the output power

13.3.1 Single-Ended (SE)

Maximum output power:

$$P_{o(0.5\%)} = \frac{\left[\frac{R_L}{R_L + R_{DSon(hs)} + R_{sL}} \times V_P \times (1 - t_{w(min)} \times 0.5 f_{osc}) \right]^2}{2R_L} \quad (1)$$

Maximum output current is internally limited to 9.2 A:

$$I_{o(peak)} = \frac{V_P \times (1 - t_{w(min)} \times 0.5 f_{osc})}{R_L + R_{DSon(hs)} + R_{sL}} \quad (2)$$

Where:

- $P_{o(0.5\%)}$: output power at the onset of clipping
- R_L : load impedance
- $R_{DSon(hs)}$: high-side R_{DSon} of power stage output DMOS (temperature dependent)
- R_{sL} : series impedance of the filter coil
- V_P : single-sided supply voltage or $0.5 \times (V_{DD} + |V_{SS}|)$
- $t_{w(min)}$: minimum pulse width (typical 150 ns, temperature dependent)
- f_{osc} : oscillator frequency

Remark: Note that $I_{o(peak)}$ should be less than 9.2 A ([Section 8.3.2](#)). $I_{o(peak)}$ is the sum of the current through the load and the ripple current. The value of the ripple current is dependent on the coil inductance and the voltage drop across the coil.

13.3.2 Bridge-Tied Load (BTL)

Maximum output power:

$$P_{o(0.5\%)} = \frac{\left[\frac{R_L}{R_L + R_{DSon(hs)} + R_{DSon(ls)}} \times 2V_P \times (1 - t_{w(min)} \times 0.5f_{osc}) \right]^2}{2R_L} \quad (3)$$

Maximum output current internally limited to 9.2 A:

$$I_{o(peak)} = \frac{2V_P \times (1 - t_{w(min)} \times 0.5f_{osc})}{R_L + (R_{DSon(hs)} + R_{DSon(ls)}) + 2R_{sL}} \quad (4)$$

Where:

- $P_{o(0.5\%)}$: output power at the onset of clipping
- R_L : load impedance
- $R_{DSon(hs)}$: high-side R_{DSon} of power stage output DMOS (temperature dependent)
- $R_{DSon(ls)}$: low-side R_{DSon} of power stage output DMOS (temperature dependent)
- R_{sL} : series impedance of the filter coil
- V_P : single-sided supply voltage or $0.5 \times (V_{DD} + |V_{SS}|)$
- $t_{w(min)}$: minimum pulse width (typical 150 ns, temperature dependent)
- f_{osc} : oscillator frequency

Remark: Note that $I_{o(peak)}$ should be less than 9.2 A; see [Section 8.3.2](#). $I_{o(peak)}$ is the sum of the current through the load and the ripple current. The value of the ripple current is dependent on the coil inductance and the voltage drop across the coil.

13.4 External clock

To ensure duty cycle-independent operation, the external clock frequency is divided by two internally. The external clock frequency is therefore twice the internal clock frequency (typically $2 \times 350 \text{ kHz} = 700 \text{ kHz}$).

If several Class D amplifiers are used in a single application, it is recommended that all the devices run at the same switching frequency. This can be achieved by connecting the OSC pins together and feeding them from an external oscillator. When using an external oscillator, it is necessary to force pin OSC to a DC level above SGND. This disables the internal oscillator and causes the PWM to switch at half the external clock frequency.

The internal oscillator requires an external resistor R_{OSC} , connected between pin OSC and pin VSSA. R_{OSC} must be removed when using an external oscillator.

The noise generated by the internal oscillator is supply voltage dependent. An external low-noise oscillator is recommended for low-noise applications running at high supply voltages.

13.5 Heatsink requirements

An external heatsink must be connected to the TDA8950.

Equation 5 defines the relationship between maximum power dissipation before activation of TFB and total thermal resistance from junction to ambient.

$$R_{th(j-a)} = \frac{T_j - T_{amb}}{P} \tag{5}$$

Power dissipation (P) is determined by the efficiency of the TDA8950. Efficiency measured as a function of output power is given in Figure 20. Power dissipation can be derived as a function of output power as shown in Figure 19.

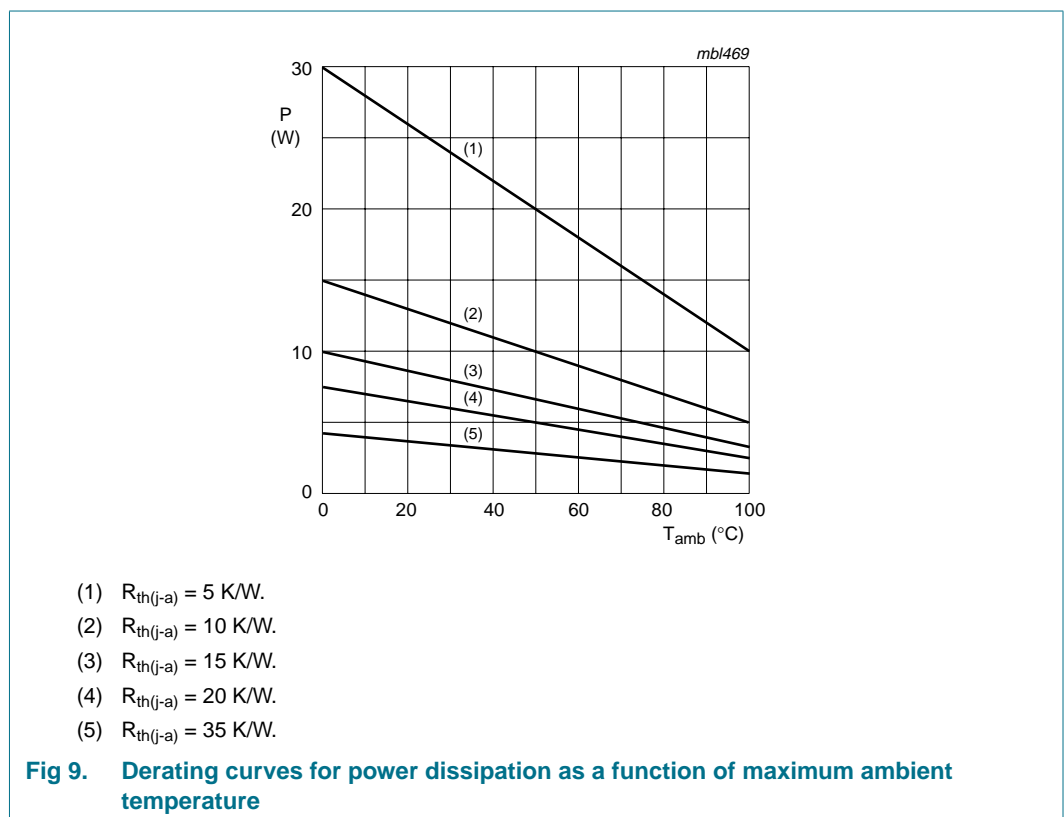

In the following example, a heatsink calculation is made for an 8 Ω BTL application with a ±30 V supply:

The audio signal has a crest factor of 10 (the ratio between peak power and average power (20 dB)); this means that the average output power is $\frac{1}{10}$ of the peak power.

Thus, the peak RMS output power level is the 0.5 % THD level, i.e. 170 W.

The average power is then $\frac{1}{10} \times 170 \text{ W} = 17 \text{ W}$.

The dissipated power at an output power of 17 W is approximately 7 W.

When the maximum expected ambient temperature is 50 °C, the total $R_{th(j-a)}$ becomes

$$\frac{(148 - 50)}{7} = 14 \text{ K/W}$$

$$R_{th(j-a)} = R_{th(j-c)} + R_{th(c-h)} + R_{th(h-a)}$$

$R_{th(j-c)}$ (thermal resistance from junction to case) = 1.1 K/W

$R_{th(c-h)}$ (thermal resistance from case to heatsink) = 0.5 K/W to 1 K/W (dependent on mounting)

So the thermal resistance between heatsink and ambient temperature is:

$$R_{th(h-a)} \text{ (thermal resistance from heatsink to ambient)} = 14 - (1.1 + 1) = 11.9 \text{ K/W}$$

The derating curves for power dissipation (for several $R_{th(j-a)}$ values) are illustrated in [Figure 9](#). A maximum junction temperature $T_j = 150 \text{ °C}$ is taken into account. The maximum allowable power dissipation for a given heatsink size can be derived, or the required heatsink size can be determined, at a required power dissipation level; see [Figure 9](#).

13.6 Pumping effects

In a typical stereo single-ended configuration, the TDA8950 is supplied by a symmetrical supply voltage (e.g. $V_{DD} = 30 \text{ V}$ and $V_{SS} = -30 \text{ V}$). When the amplifier is used in an SE configuration, a 'pumping effect' can occur. During one switching interval, energy is taken from one supply (e.g. V_{DD}), while a part of that energy is returned to the other supply line (e.g. V_{SS}) and vice versa. When the voltage supply source cannot sink energy, the voltage across the output capacitors of that voltage supply source increases and the supply voltage is pumped to higher levels. The voltage increase caused by the pumping effect depends on:

- Speaker impedance
- Supply voltage
- Audio signal frequency
- Value of supply line decoupling capacitors
- Source and sink currents of other channels

Pumping effects should be minimized to prevent the malfunctioning of the audio amplifier and/or the voltage supply source. Amplifier malfunction due to the pumping effect can trigger UVP, OVP or UBP.

The most effective way to avoid pumping effects is to connect the TDA8950 in a mono full-bridge configuration. In the case of stereo single-ended applications, it is advised to connect the inputs in anti-phase (see [Section 8.4](#)). The power supply can also be adapted; for example, by increasing the values of the supply line decoupling capacitors.

13.7 Application schematic

Notes on the application schematic:

- Connect a solid ground plane around the switching amplifier to avoid emissions
- Place 100 nF capacitors as close as possible to the TDA8950 power supply pins
- Connect the heatsink to the ground plane or to VSSPn using a 100 nF capacitor
- Use a thermally conductive, electrically non-conductive, Sil-Pad between the TDA8950 heat spreader and the external heatsink
- The heat spreader of the TDA8950 is internally connected to VSSD
- Use differential inputs for the most effective system level audio performance with unbalanced signal sources. In case of hum due to floating inputs, connect the shielding or source ground to the amplifier ground.

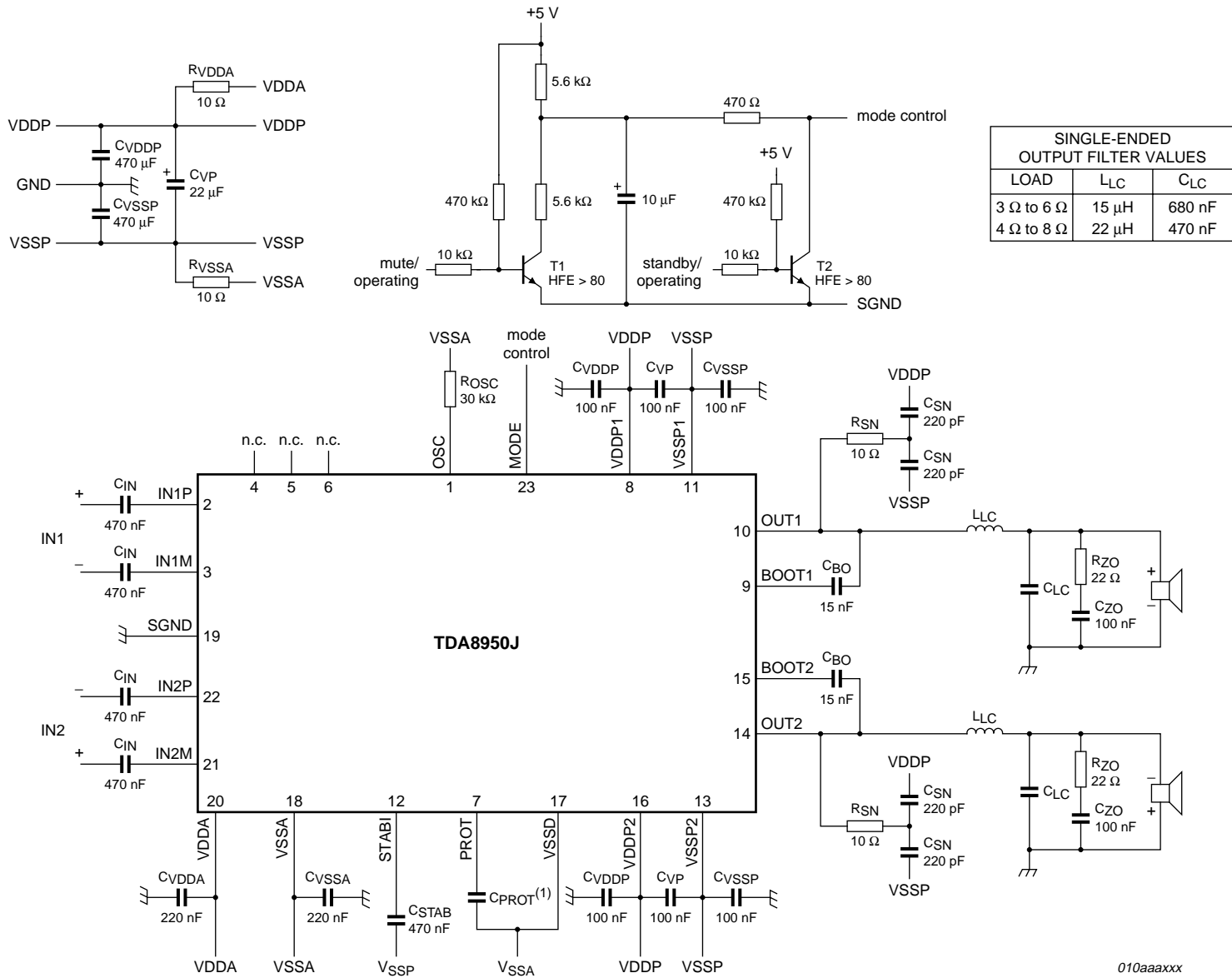

(1) The value of C_{PROT} can be in the range 10 pF to 220 pF (see [Section 8.3.2](#))

Fig 10. Typical application diagram

13.8 Curves measured in reference design

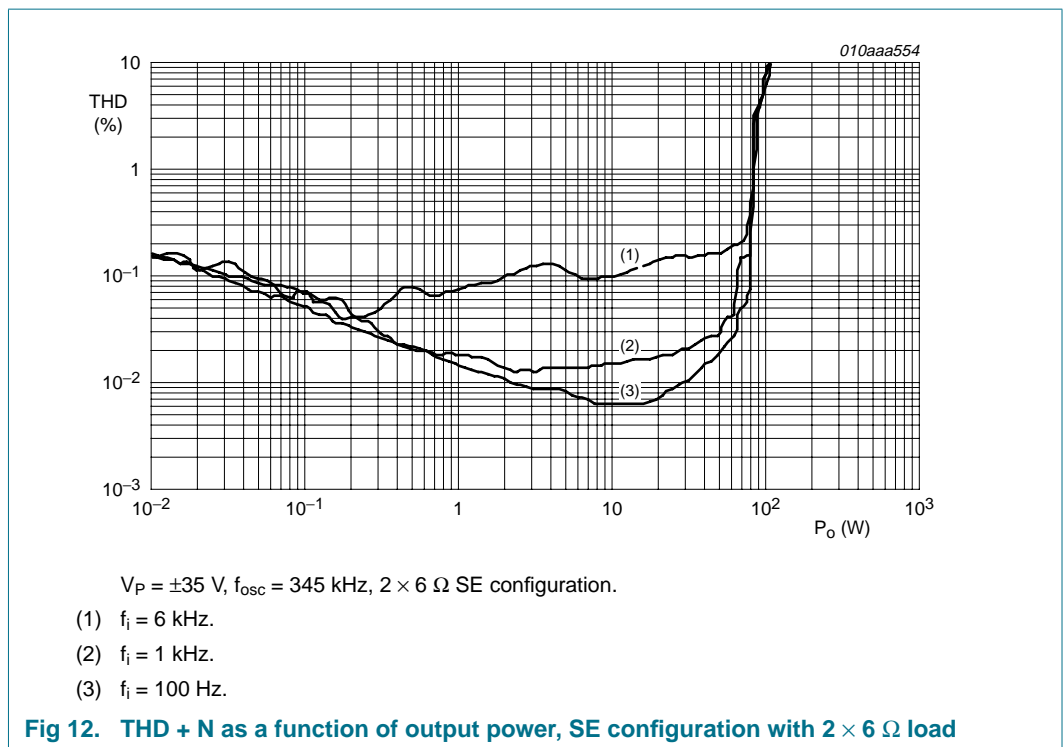
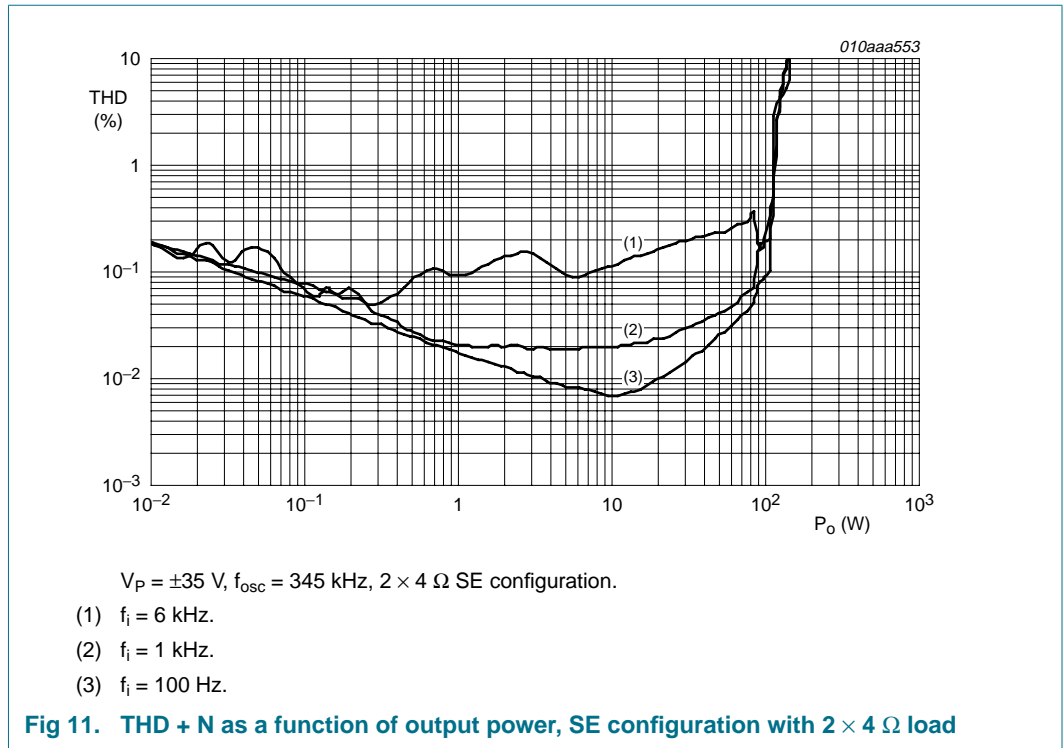

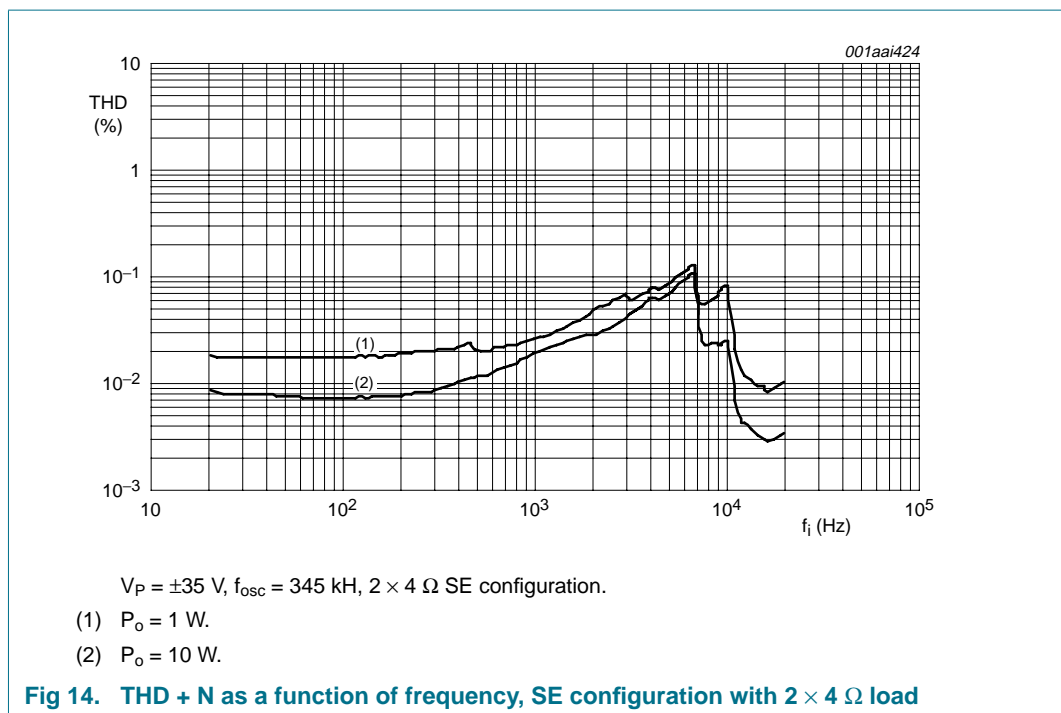
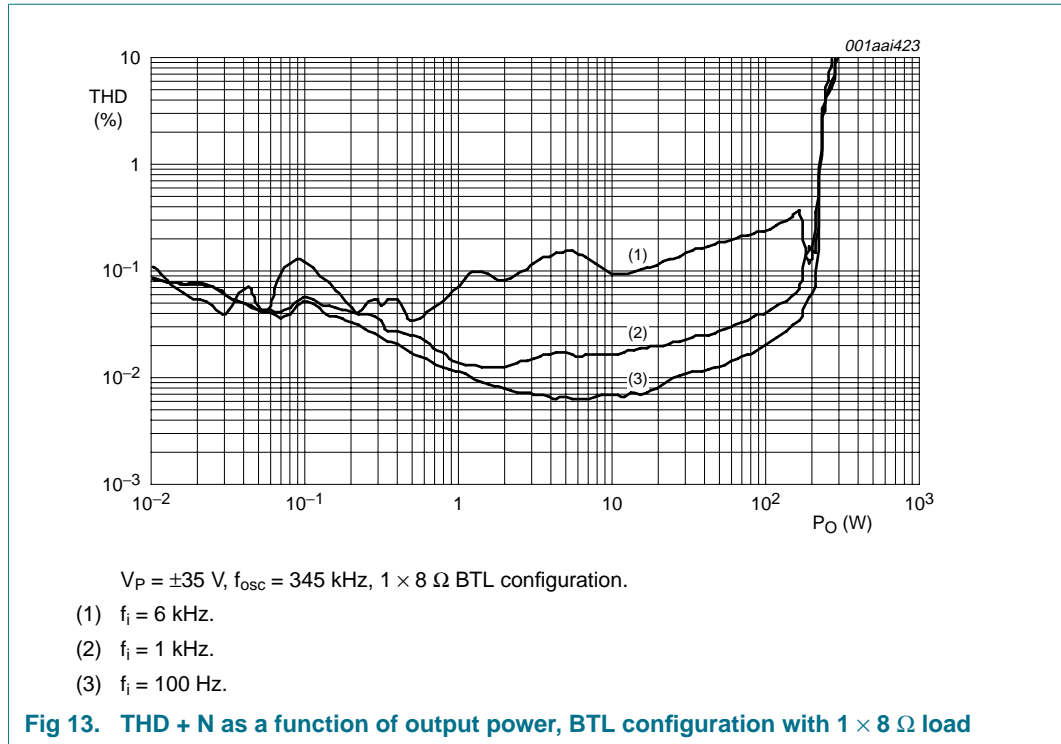

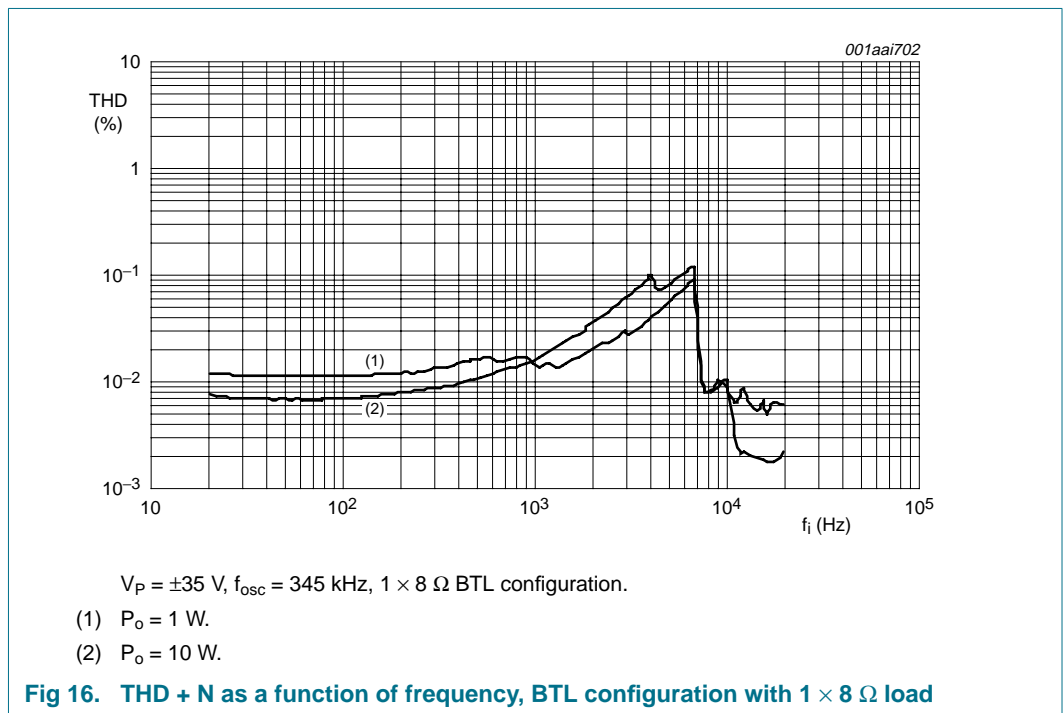
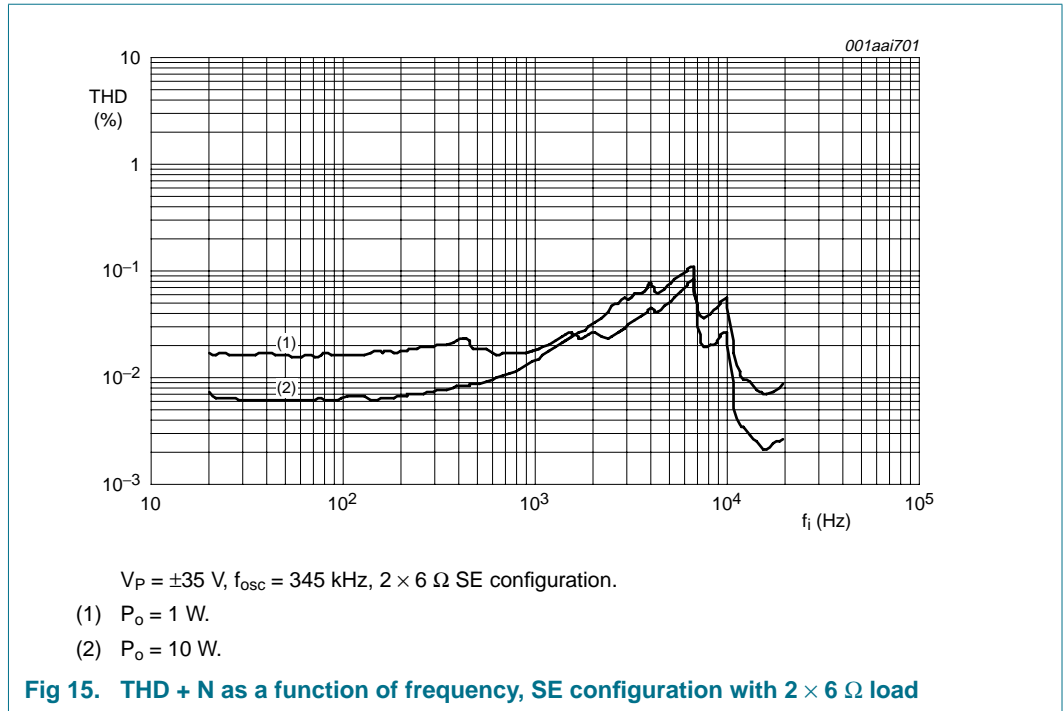

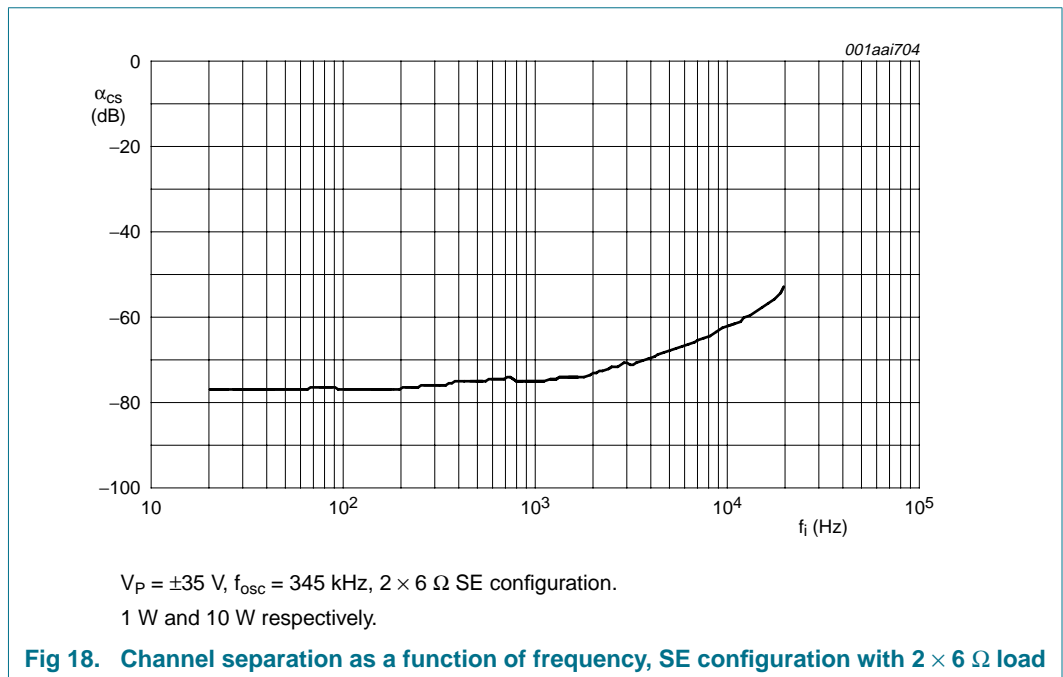
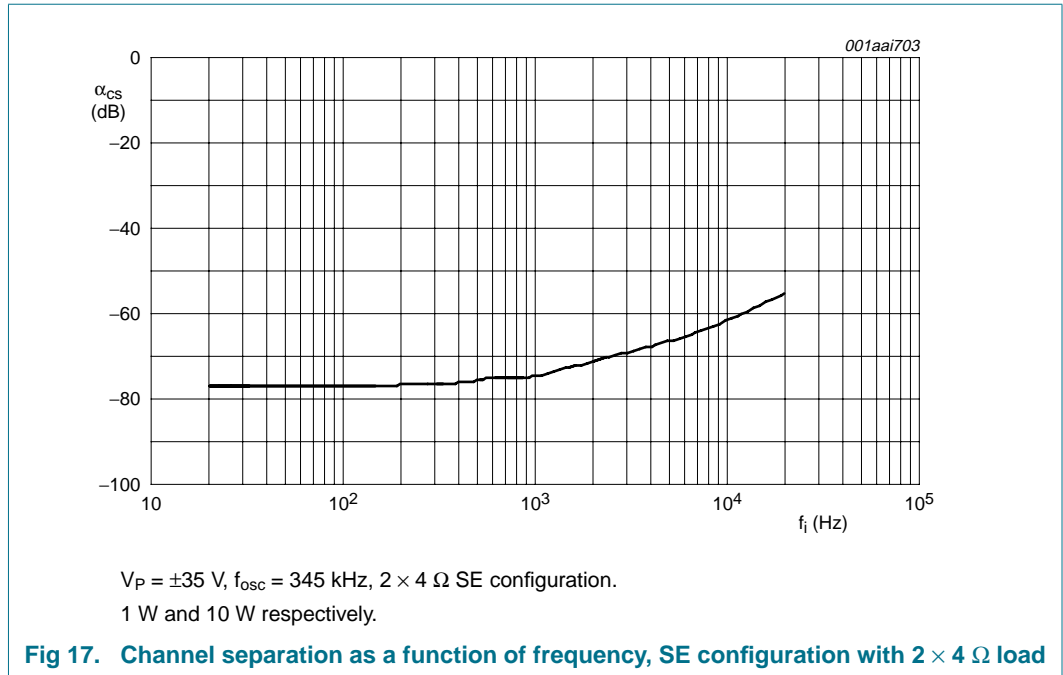

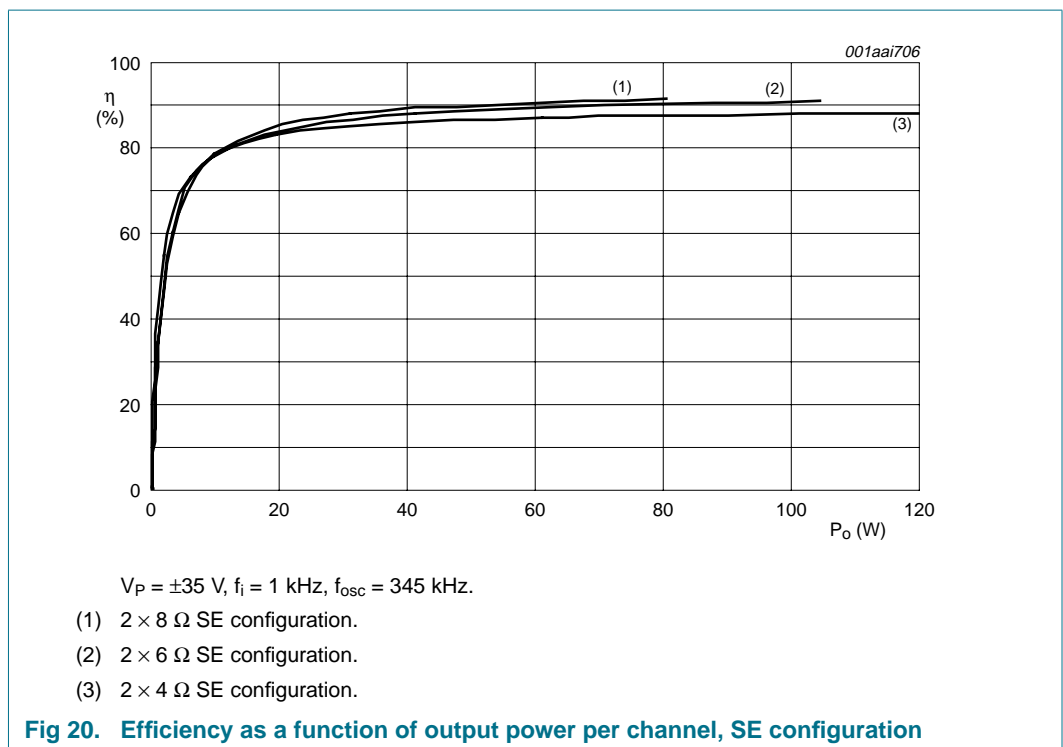
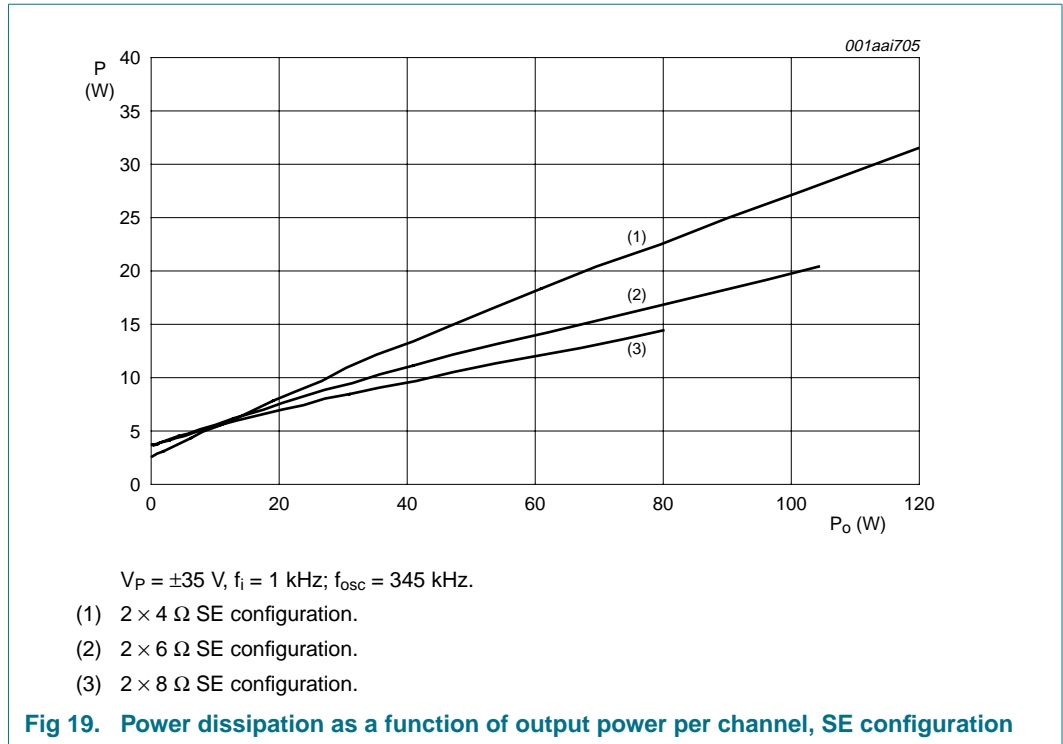

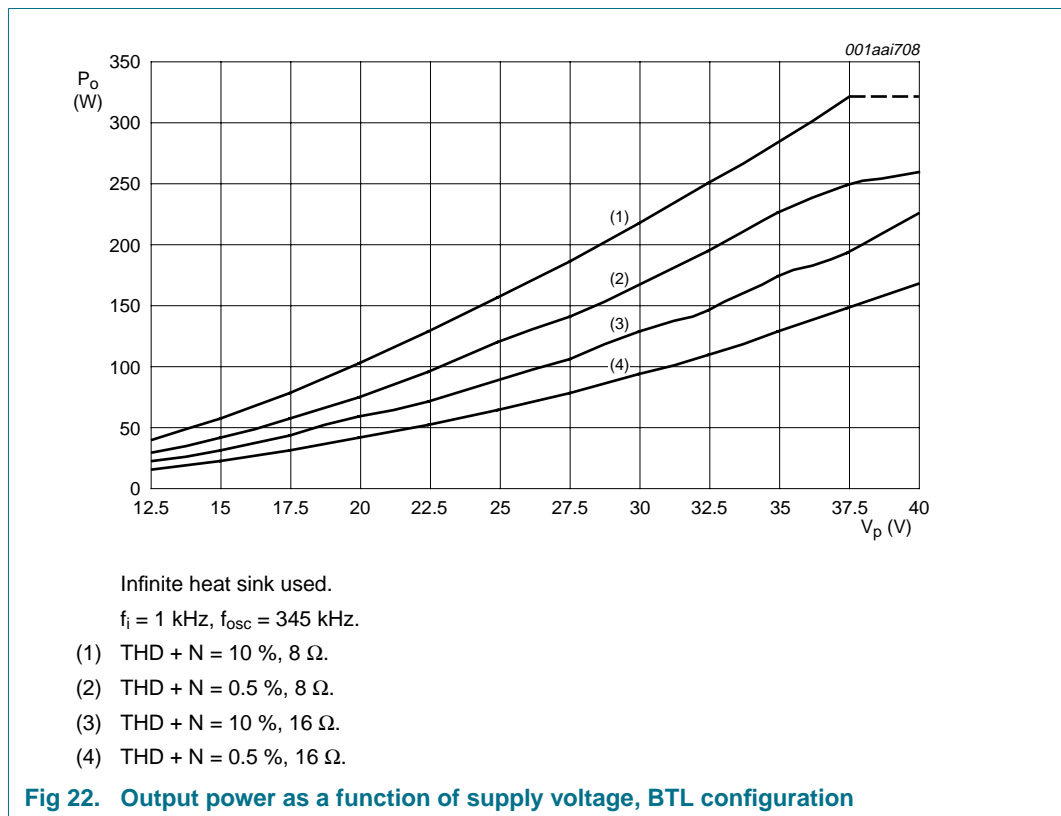
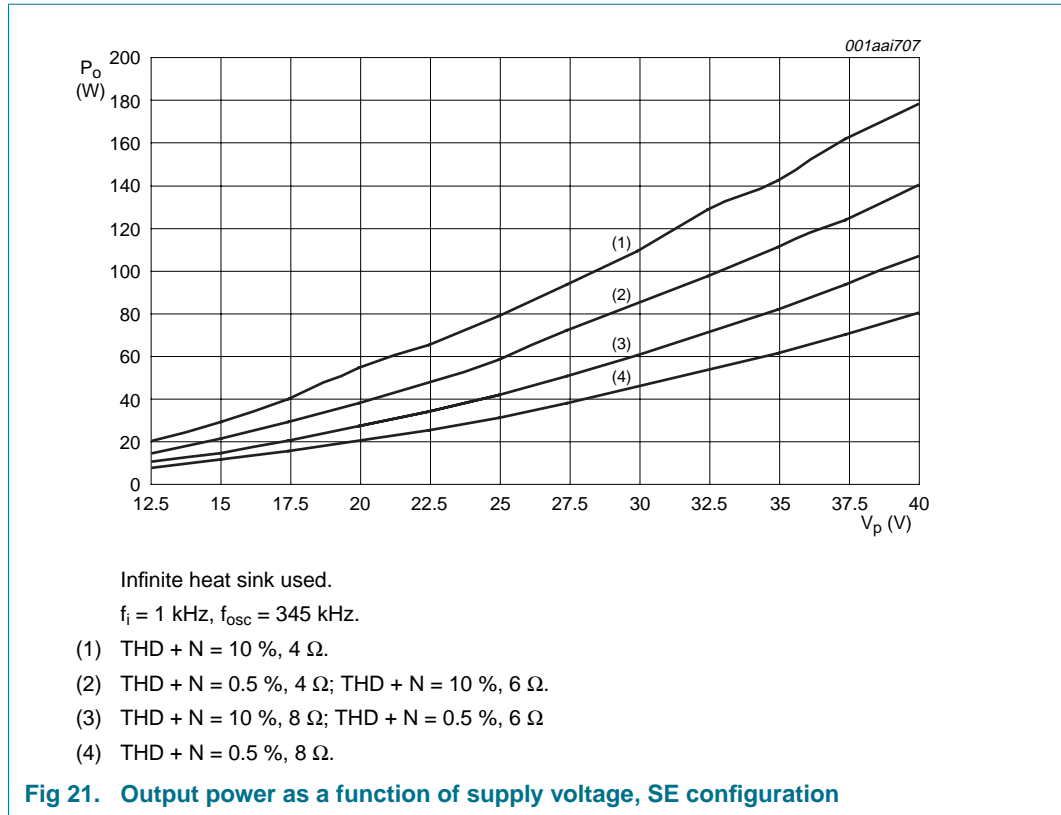

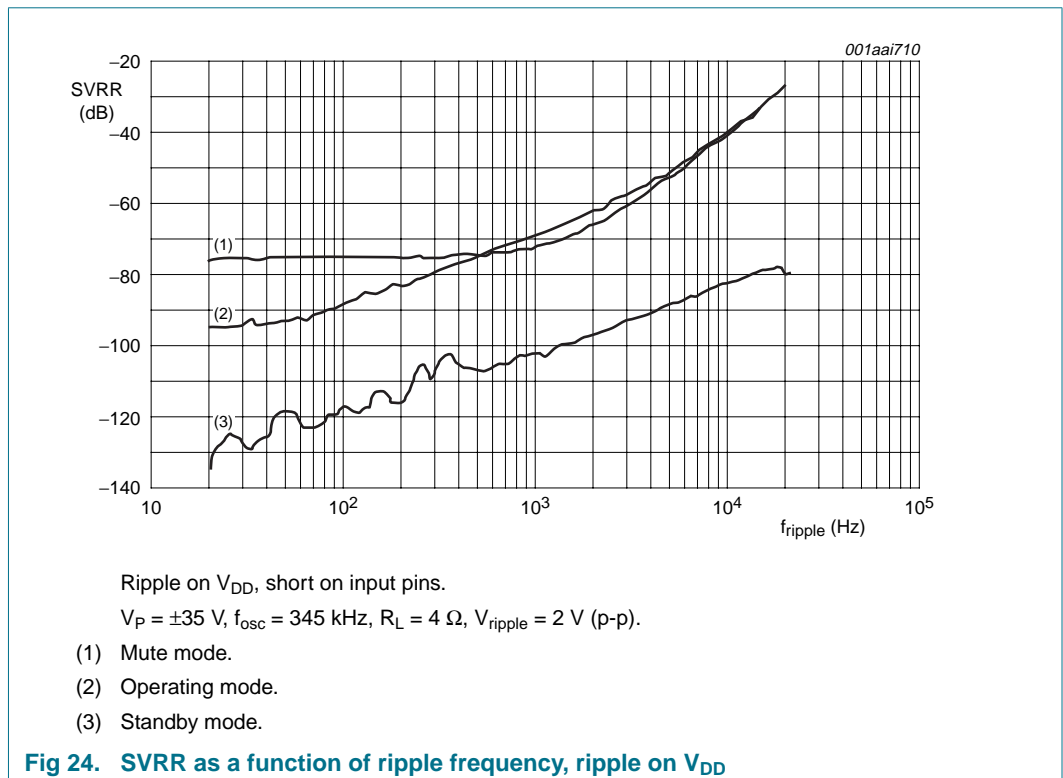
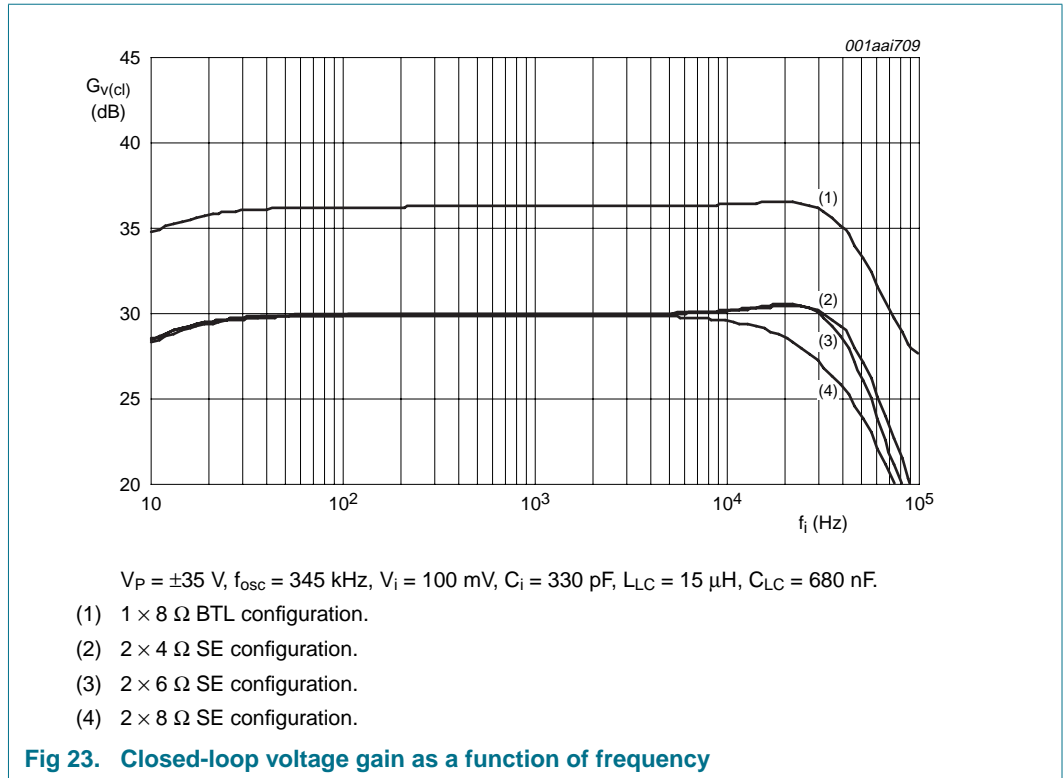

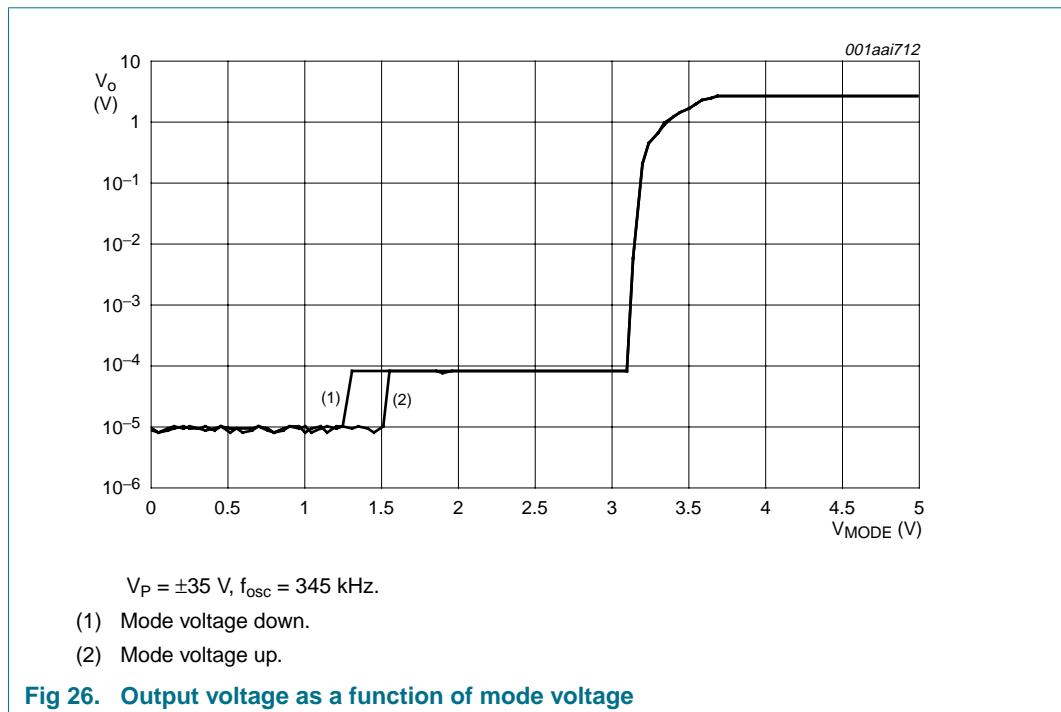
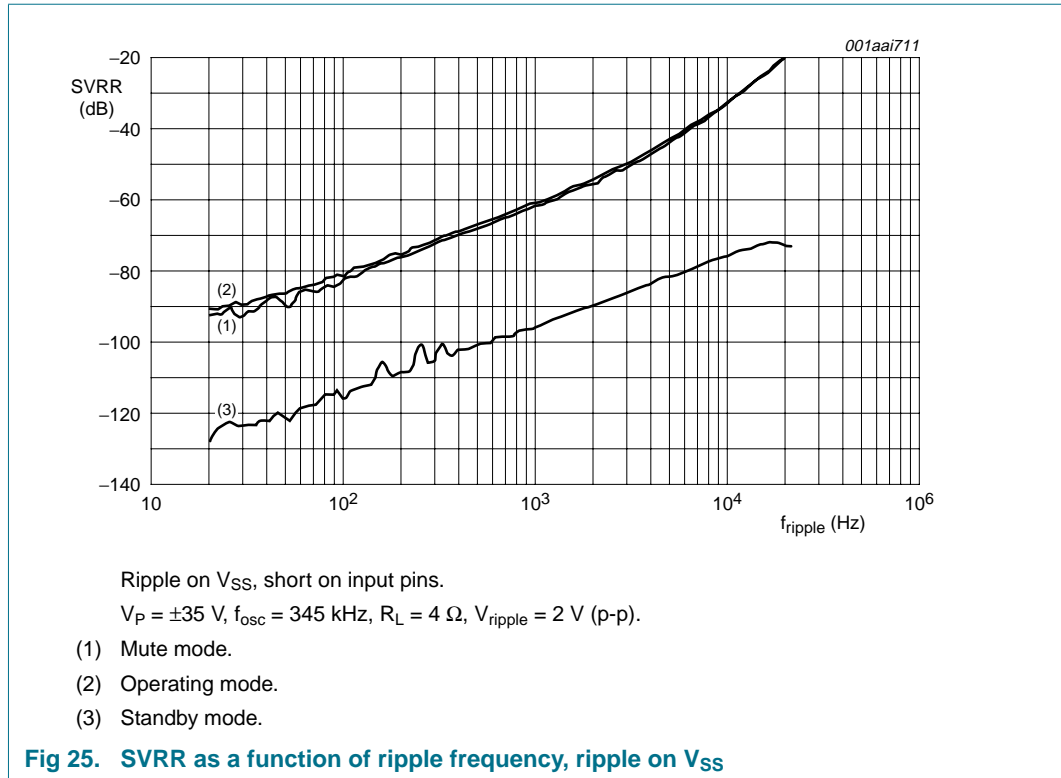

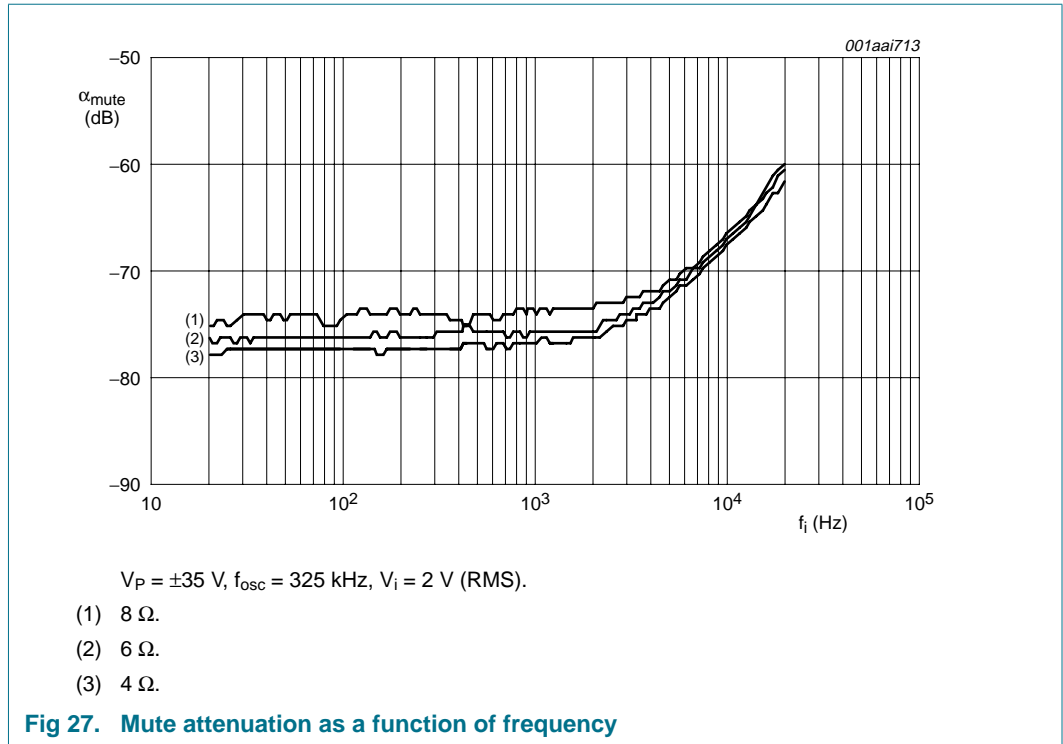

14. Package outline

DBS23P: plastic DIL-bent-SIL power package; 23 leads (straight lead length 3.2 mm)

SOT411-1

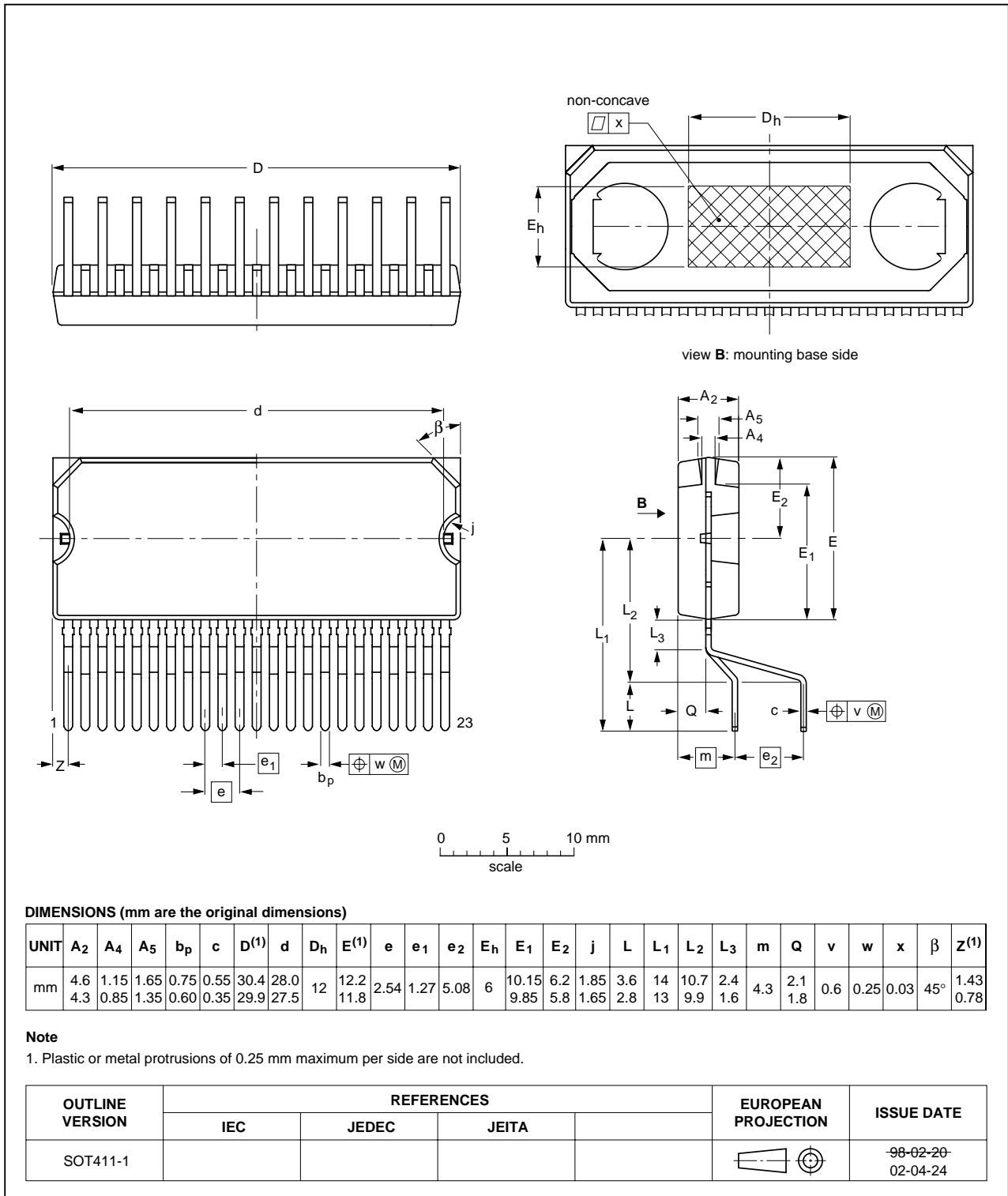

Fig 28. Package outline SOT411-1 (DBS23P)

HSOP24: plastic, heatsink small outline package; 24 leads; low stand-off height

SOT566-3

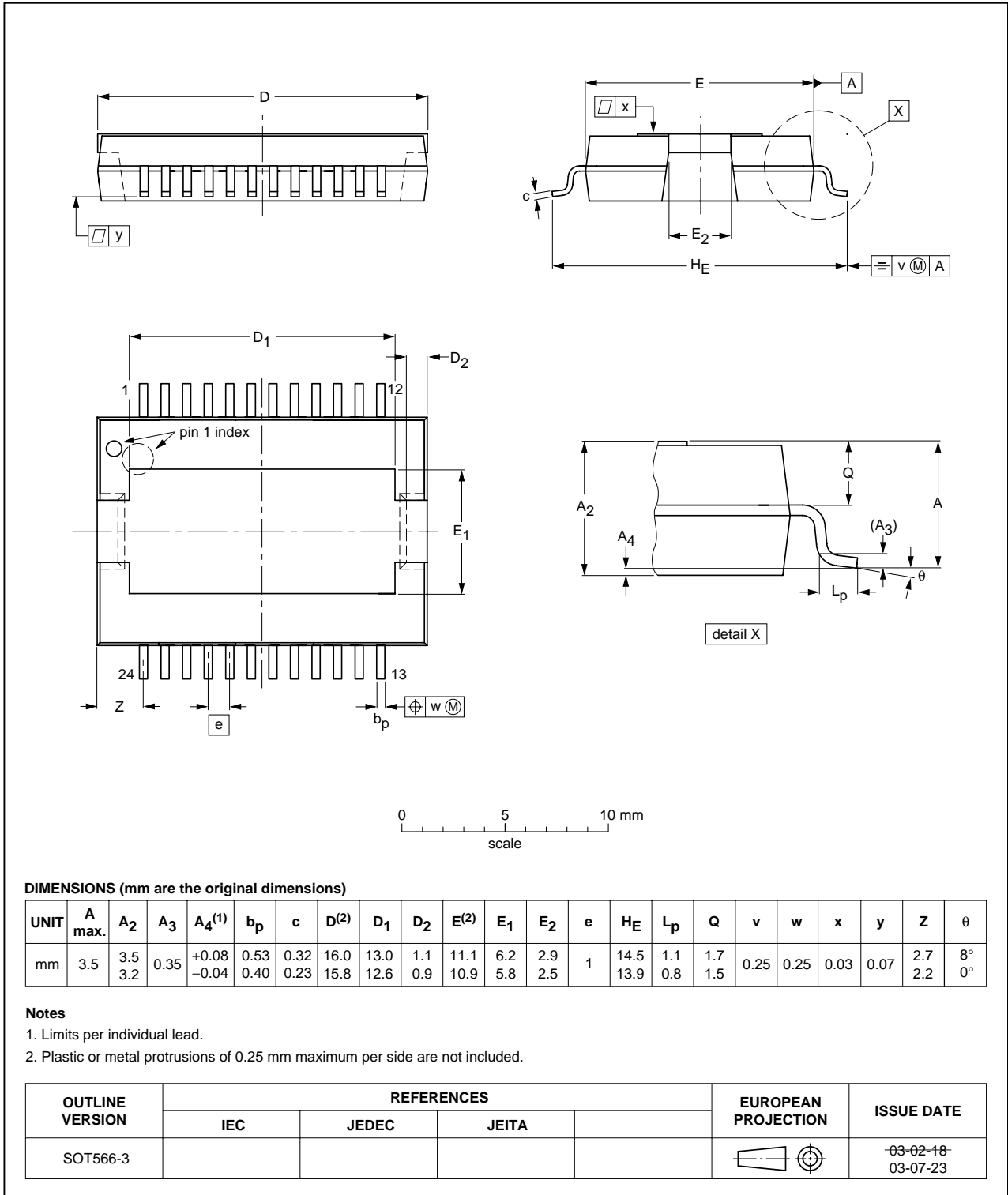

Fig 29. Package outline SOT566-3 (HSOP24)

15. Soldering of SMD packages

This text provides a very brief insight into a complex technology. A more in-depth account of soldering ICs can be found in Application Note *AN10365 "Surface mount reflow soldering description"*.

15.1 Introduction to soldering

Soldering is one of the most common methods through which packages are attached to Printed Circuit Boards (PCBs), to form electrical circuits. The soldered joint provides both the mechanical and the electrical connection. There is no single soldering method that is ideal for all IC packages. Wave soldering is often preferred when through-hole and Surface Mount Devices (SMDs) are mixed on one printed wiring board; however, it is not suitable for fine pitch SMDs. Reflow soldering is ideal for the small pitches and high densities that come with increased miniaturization.

15.2 Wave and reflow soldering

Wave soldering is a joining technology in which the joints are made by solder coming from a standing wave of liquid solder. The wave soldering process is suitable for the following:

- Through-hole components
- Leaded or leadless SMDs, which are glued to the surface of the printed circuit board

Not all SMDs can be wave soldered. Packages with solder balls, and some leadless packages which have solder lands underneath the body, cannot be wave soldered. Also, leaded SMDs with leads having a pitch smaller than ~0.6 mm cannot be wave soldered, due to an increased probability of bridging.

The reflow soldering process involves applying solder paste to a board, followed by component placement and exposure to a temperature profile. Leaded packages, packages with solder balls, and leadless packages are all reflow solderable.

Key characteristics in both wave and reflow soldering are:

- Board specifications, including the board finish, solder masks and vias
- Package footprints, including solder thieves and orientation
- The moisture sensitivity level of the packages
- Package placement
- Inspection and repair
- Lead-free soldering versus SnPb soldering

15.3 Wave soldering

Key characteristics in wave soldering are:

- Process issues, such as application of adhesive and flux, clinching of leads, board transport, the solder wave parameters, and the time during which components are exposed to the wave
- Solder bath specifications, including temperature and impurities

15.4 Reflow soldering

Key characteristics in reflow soldering are:

- Lead-free versus SnPb soldering; note that a lead-free reflow process usually leads to higher minimum peak temperatures (see [Figure 30](#)) than a SnPb process, thus reducing the process window
- Solder paste printing issues including smearing, release, and adjusting the process window for a mix of large and small components on one board
- Reflow temperature profile; this profile includes preheat, reflow (in which the board is heated to the peak temperature) and cooling down. It is imperative that the peak temperature is high enough for the solder to make reliable solder joints (a solder paste characteristic). In addition, the peak temperature must be low enough that the packages and/or boards are not damaged. The peak temperature of the package depends on package thickness and volume and is classified in accordance with [Table 12](#) and [13](#)

Table 12. SnPb eutectic process (from J-STD-020C)

Package thickness (mm)	Package reflow temperature (°C)	
	Volume (mm ³)	
	< 350	≥ 350
< 2.5	235	220
≥ 2.5	220	220

Table 13. Lead-free process (from J-STD-020C)

Package thickness (mm)	Package reflow temperature (°C)		
	Volume (mm ³)		
	< 350	350 to 2000	> 2000
< 1.6	260	260	260
1.6 to 2.5	260	250	245
> 2.5	250	245	245

Moisture sensitivity precautions, as indicated on the packing, must be respected at all times.

Studies have shown that small packages reach higher temperatures during reflow soldering, see [Figure 30](#).

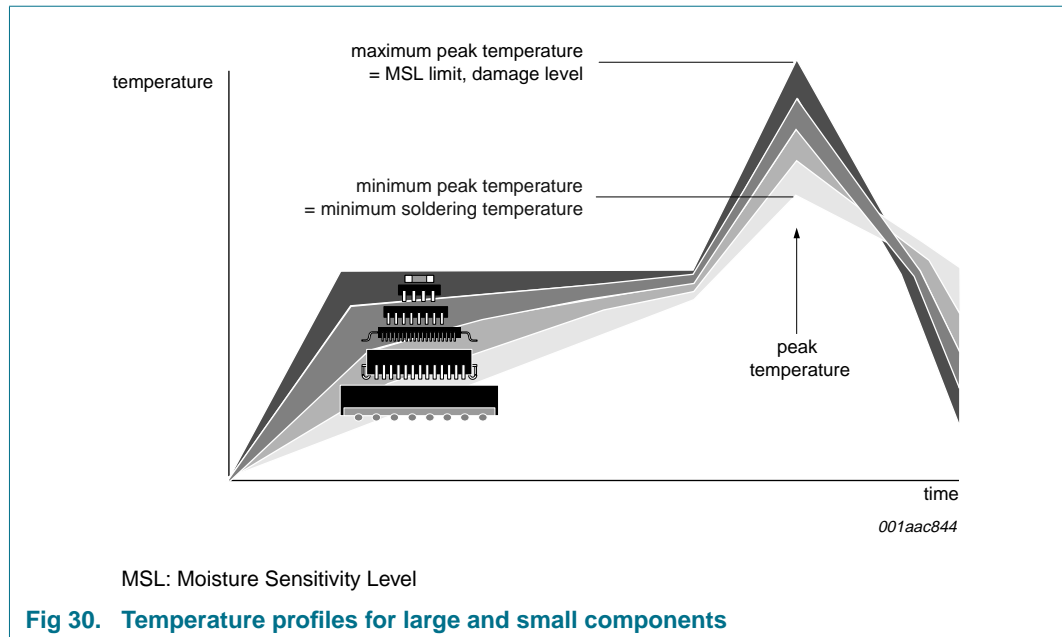

For further information on temperature profiles, refer to Application Note *AN10365* "Surface mount reflow soldering description".

16. Soldering of through-hole mount packages

16.1 Introduction to soldering through-hole mount packages

This text gives a very brief insight into wave, dip and manual soldering.

Wave soldering is the preferred method for mounting of through-hole mount IC packages on a printed-circuit board.

16.2 Soldering by dipping or by solder wave

Driven by legislation and environmental forces the worldwide use of lead-free solder pastes is increasing. Typical dwell time of the leads in the wave ranges from 3 seconds to 4 seconds at 250 °C or 265 °C, depending on solder material applied, SnPb or Pb-free respectively.

The total contact time of successive solder waves must not exceed 5 seconds.

The device may be mounted up to the seating plane, but the temperature of the plastic body must not exceed the specified maximum storage temperature ($T_{stg(max)}$). If the printed-circuit board has been pre-heated, forced cooling may be necessary immediately after soldering to keep the temperature within the permissible limit.

16.3 Manual soldering

Apply the soldering iron (24 V or less) to the lead(s) of the package, either below the seating plane or not more than 2 mm above it. If the temperature of the soldering iron bit is less than 300 °C it may remain in contact for up to 10 seconds. If the bit temperature is between 300 °C and 400 °C, contact may be up to 5 seconds.

16.4 Package related soldering information

Table 14. Suitability of through-hole mount IC packages for dipping and wave soldering

Package	Soldering method	
	Dipping	Wave
CPGA, HCPGA	-	suitable
DBS, DIP, HDIP, RDBS, SDIP, SIL	suitable	suitable ^[1]
PMFP ^[2]	-	not suitable

[1] For SDIP packages, the longitudinal axis must be parallel to the transport direction of the printed-circuit board.

[2] For PMFP packages hot bar soldering or manual soldering is suitable.

17. Revision history

Table 15. Revision history

Document ID	Release date	Data sheet status	Change notice	Supersedes
TDA8950_2	20090611	Product data sheet		TDA8950_1
Modifications	<ul style="list-style-type: none"> Parameter values revised throughout. Revised Figure 4, Figure 10, Figure 11 and Figure 12. 			
TDA8950_1	20080909	Preliminary data sheet	-	-

18. Legal information

18.1 Data sheet status

Document status ^{[1][2]}	Product status ^[3]	Definition
Objective [short] data sheet	Development	This document contains data from the objective specification for product development.
Preliminary [short] data sheet	Qualification	This document contains data from the preliminary specification.
Product [short] data sheet	Production	This document contains the product specification.

[1] Please consult the most recently issued document before initiating or completing a design.

[2] The term 'short data sheet' is explained in section "Definitions".

[3] The product status of device(s) described in this document may have changed since this document was published and may differ in case of multiple devices. The latest product status information is available on the Internet at URL <http://www.nxp.com>.

18.2 Definitions

Draft — The document is a draft version only. The content is still under internal review and subject to formal approval, which may result in modifications or additions. NXP Semiconductors does not give any representations or warranties as to the accuracy or completeness of information included herein and shall have no liability for the consequences of use of such information.

Short data sheet — A short data sheet is an extract from a full data sheet with the same product type number(s) and title. A short data sheet is intended for quick reference only and should not be relied upon to contain detailed and full information. For detailed and full information see the relevant full data sheet, which is available on request via the local NXP Semiconductors sales office. In case of any inconsistency or conflict with the short data sheet, the full data sheet shall prevail.

18.3 Disclaimers

General — Information in this document is believed to be accurate and reliable. However, NXP Semiconductors does not give any representations or warranties, expressed or implied, as to the accuracy or completeness of such information and shall have no liability for the consequences of use of such information.

Right to make changes — NXP Semiconductors reserves the right to make changes to information published in this document, including without limitation specifications and product descriptions, at any time and without notice. This document supersedes and replaces all information supplied prior to the publication hereof.

Suitability for use — NXP Semiconductors products are not designed, authorized or warranted to be suitable for use in medical, military, aircraft, space or life support equipment, nor in applications where failure or malfunction of an NXP Semiconductors product can reasonably be expected to result in personal injury, death or severe property or environmental

damage. NXP Semiconductors accepts no liability for inclusion and/or use of NXP Semiconductors products in such equipment or applications and therefore such inclusion and/or use is at the customer's own risk.

Applications — Applications that are described herein for any of these products are for illustrative purposes only. NXP Semiconductors makes no representation or warranty that such applications will be suitable for the specified use without further testing or modification.

Limiting values — Stress above one or more limiting values (as defined in the Absolute Maximum Ratings System of IEC 60134) may cause permanent damage to the device. Limiting values are stress ratings only and operation of the device at these or any other conditions above those given in the Characteristics sections of this document is not implied. Exposure to limiting values for extended periods may affect device reliability.

Terms and conditions of sale — NXP Semiconductors products are sold subject to the general terms and conditions of commercial sale, as published at <http://www.nxp.com/profile/terms>, including those pertaining to warranty, intellectual property rights infringement and limitation of liability, unless explicitly otherwise agreed to in writing by NXP Semiconductors. In case of any inconsistency or conflict between information in this document and such terms and conditions, the latter will prevail.

No offer to sell or license — Nothing in this document may be interpreted or construed as an offer to sell products that is open for acceptance or the grant, conveyance or implication of any license under any copyrights, patents or other industrial or intellectual property rights.

Export control — This document as well as the item(s) described herein may be subject to export control regulations. Export might require a prior authorization from national authorities.

Quick reference data — The Quick reference data is an extract of the product data given in the Limiting values and Characteristics sections of this document, and as such is not complete, exhaustive or legally binding.

18.4 Trademarks

Notice: All referenced brands, product names, service names and trademarks are the property of their respective owners.

19. Contact information

For more information, please visit: <http://www.nxp.com>

For sales office addresses, please send an email to: salesaddresses@nxp.com

20. Contents

1	General description	1	16.1	Introduction to soldering through-hole mount packages	36
2	Features	1	16.2	Soldering by dipping or by solder wave	36
3	Applications	1	16.3	Manual soldering	36
4	Quick reference data	2	16.4	Package related soldering information	37
5	Ordering information	2	17	Revision history	37
6	Block diagram	3	18	Legal information	38
7	Pinning information	4	18.1	Data sheet status	38
7.1	Pinning	4	18.2	Definitions	38
7.2	Pin description	5	18.3	Disclaimers	38
8	Functional description	5	18.4	Trademarks	38
8.1	General	5	19	Contact information	38
8.2	Pulse-width modulation frequency	8	20	Contents	39
8.3	Protection	8			
8.3.1	Thermal protection	8			
8.3.1.1	Thermal FoldBack (TFB)	8			
8.3.1.2	OverTemperature Protection (OTP)	9			
8.3.2	OverCurrent Protection (OCP)	9			
8.3.3	Window Protection (WP)	10			
8.3.4	Supply voltage protection	11			
8.4	Differential audio inputs	11			
9	Limiting values	12			
10	Thermal characteristics	12			
11	Static characteristics	13			
12	Dynamic characteristics	14			
12.1	Switching characteristics	14			
12.2	Stereo SE configuration characteristics	15			
12.3	Mono BTL application characteristics	16			
13	Application information	17			
13.1	Mono BTL application	17			
13.2	Pin MODE	17			
13.3	Estimating the output power	17			
13.3.1	Single-Ended (SE)	17			
13.3.2	Bridge-Tied Load (BTL)	18			
13.4	External clock	18			
13.5	Heatsink requirements	19			
13.6	Pumping effects	20			
13.7	Application schematic	21			
13.8	Curves measured in reference design	23			
14	Package outline	32			
15	Soldering of SMD packages	34			
15.1	Introduction to soldering	34			
15.2	Wave and reflow soldering	34			
15.3	Wave soldering	34			
15.4	Reflow soldering	35			
16	Soldering of through-hole mount packages	36			

Please be aware that important notices concerning this document and the product(s) described herein, have been included in section 'Legal information'.

founded by

PHILIPS

© NXP B.V. 2009.

All rights reserved.

For more information, please visit: <http://www.nxp.com>

For sales office addresses, please send an email to: salesaddresses@nxp.com

Date of release: 11 June 2009

Document identifier: TDA8950_2

Mouser Electronics

Authorized Distributor

Click to View Pricing, Inventory, Delivery & Lifecycle Information:

[NXP:](#)

[TDA8950J/N1,112](#) [TDA8950TH/N1,118](#)